

ESTUDIO DE INVESTIGACIÓN DE LA UNIVERSIDAD DE MICHIGAN

Puede ser consultado en:

<http://www.hti.umich.edu/cgi/t/text/text-idx?sid=50cf84488b83cc2b8ba0554be1cc5c98;c=umtri;idno=88519.0001.001>

# An Operational Field Test Of Long Combination Vehicles Using ABS And C-Dollies

Volume I

Fuel Technical Report

UMTRI-95-45-1

Submitted to:

U.S. Department of Transportation  
National Highway Traffic Safety Administration  
Task Order No. NRD-01-G-37247  
Contract No. D1NE122-92-D-07003

November 1995

---

The University of Michigan  
Transportation Research Institute

ESTUDIO DE INVESTIGACIÓN DE LA UNIVERSIDAD DE MICHIGAN  
Puede ser consultado en:

<http://www.hti.umich.edu/cgi/t/text/text-idx?sid=50cf84488b83cc2b8ba0554be1cc5c98;c=umtri;idno=88519.0001.001>

## ACKNOWLEDGMENTS

The success of the LCV operational field test depended heavily on the cooperation of many organizations and many individuals. The authors wish to acknowledge that cooperation most enthusiastically and extend our sincere thanks to all who were involved.

First and foremost are the five commercial fleets who participated in the project. These *volunteers* were, quite simply, the most important element of the project. For them, the project meant a fair amount of work and a substantial logistical burden on top of their normal operations, all for little direct return. Without their good will and efforts, freely given, there simply would not have been a field study. Our thanks go to:

**Albertsons** and Scott Jardine, Ted Sturgill, and Rich Wilson

**Fred Meyer/Distribution Trucking Company** and Cy Green, Lindsay Ashmore, Mick Cortopassi, Chuck Craver, and Kerry Marshall

**Thrifty PayLess, Incorporated** and Jim Foster, Dave Low, Craig Southard, Jerry Derryberry, and Rick Dralle

**Silver Eagle Company** and Ross Gausson, Gary Gausson, Bill Heater, David Feld, and Woody Woodworth

**ShopKo Stores/SVS Trucking, Incorporated** and Herman Miller, Rick Cooper, Lou Karakas, Vince Huerta, Stien Gearhart, and Don McKaig

Next are all the drivers. One hundred ninety-one individuals took at least one trip under the field study and, in the process, suffered the indignities of our trip logs and data cards. Although our thanks go out to all of them, there are too many to list here, so we represent them all with the top twenty according to the number of trips they took: Jack Sherwood (172), Joe Colley (160), Brian Resch (139), Glenn Procop (132), Jim DeVries (120), Robert B. Armfield (112), Jimmie W. Grist (109), Mike Huppi (55), Michael Hamilton (51), Jim Coburn (48), Doug Thomas (48), Robert Welsh (48), Leon Anderson (47), James Anslow (47), Mel Ingram (42), Greg Carrick (40), James Hendry (37), Steve Trachsel (35), Lynn Baustian (30), and Gerry Lais (28). You may find the names of all 191 divers in volume 2, appendix G of this report.

A number of companies supplied hardware and services to this project. Although they did not donate their products or services, they often freely gave us special attention above and beyond the call of duty. Our thanks go to the following plus all the other individuals in these organizations who contributed to the project: *Allied Signal* and Merlin Hutchins; *Independent Trailer and Repair* and Boyd Nash; *Midland-Grau* and Dave Engelbert; *Rockwell WABCO* and Bob Sibley; *Vehicle Monitor Corporation* and Mike Van Schoiack; *Freightliner Corporation* and Gary Rossow; *Fruehauf Trailer (Portland)* and Keith Munn;

ESTUDIO DE INVESTIGACIÓN DE LA UNIVERSIDAD DE MICHIGAN

Puede ser consultado en:

<http://www.hti.umich.edu/cgi/t/text/text-idx?sid=50cf84488b83cc2b8ba0554be1cc5c98;c=umtri;idno=88519.0001.001>

*Idaho Peterbilt and Kirk Bauer; Portland Freightliner and Chris Payne; TransCorp NationalLease and Al Savola; Western Trailers and Larry Nelsen; Wisconsin Peterbilt and Wayne Selner.*

We also wish to thank Michael Meredith and the Oregon Trucking Associations for their assistance.

Finally, special thanks go to Bob Clarke. Working with Bob has always been a pleasure.

## EXECUTIVE SUMMARY

### BACKGROUND

This LCV Operational Field Test is one element of the study of long combination vehicles (LCVs) mandated by the U.S. Congress in Section 4007(d) of the Intermodal Surface Transportation Efficiency Act of 1991 (ISTEA). It is also the third in a series of field tests conducted by the NHTSA investigating antilock braking systems (ABS) on heavy trucks. The first study examined the performance of ABS on 200 commercial-vehicle tractors. The second looked at ABS on fifty semitrailers. This study extends the investigation of ABS into the realm of the LCV and, at the same time, investigates the performance of double-tow-bar dollies (C-dollies) on LCVs.

The objective of this field study, as stated by the NHTSA, was to "evaluate the stability-enhancing characteristics, practicality/reliability, maintenance costs and (fleet) personnel reactions to ABS... and double-drawbar dollies." To do this, UMTRI equipped a fleet of double- and triple-trailer LCVs in *actual commercial service* with ABS and with double-tow-bar dollies and monitored their performance for a period of about one and one-half years. In that time, the test fleet accumulated approximately 1.4 million miles on trips within the study and the individual units of the test fleet accumulated over 10.5 million unit-miles. Monitoring techniques included the tracking of all maintenance work done on the vehicles in the study and measurement of the physical behavior of the vehicles on the road by means of on-board instrumentation systems.

The fleet of test vehicles was distributed among five commercial fleets operating in the northwestern region of the country where the use of LCVs is most prevalent. Four of the participants were the private fleets of large, retail-chain-store companies. The fourth was a regional LTL (less-than-truck-load) carrier. Seventeen tractors, eighty-six trailers and twenty-eight C-dollies made up the test fleet. All tractors and trailers were owned by the participating fleets. The project provided the majority of the C-dollies, although one fleet operated C-dollies prior to the study. These units were equipped with ABS, special hitching hardware to accommodate C-dollies, and instrumentation systems for monitoring vehicle behavior.

### LIMITATIONS OF THE FIELD STUDY

The authors believe that the findings set forth in this report are meaningful and that they are fair representations of the performance (economic and physical) of ABS and C-dollies in the environment of the five participating commercial fleets. At the same time, however, it

is important to indicate clearly that it is not possible to assign any measure of statistical certainty to the findings to be presented. The effort and funds expended to conduct this study were substantial. Even so, the study was too small—in number of fleets, number of units, and duration in time or in miles—to yield results that could be claimed to be representative of widespread use of ABS or C-dollies. All observations were made in the northwest and are influenced by the geography, weather, and road usage laws of that region. The participating fleets have their own distinguishing characteristics of management style, products transported, etc. Finally, the study itself unavoidably caused changes to the standard operating procedures of the participating fleets.

## FINDINGS

### Antilock Braking Systems On LCVs

The experience of this field study has lead to a number of significant observations regarding the performance of antilock braking systems on LCVs. Principal among these are:

- *ABS can be expected to play a significant, stability-enhancing role in some ten to twenty severe braking events per 100,000 miles of LCV travel (roughly a year for a professional driver). (See the lower, right-hand segments of the table.)*
- Over 80 percent of all ABS events observed involved only one unit. Twelve to 14 percent involved two units, and 4 or 5 percent of these events were severe enough to involve ABS activity on three or more units of the vehicle.
- An ABS event is experienced, on average, once in every eight to ten hours of travel. Events involving ABS activity on two units occur about once every seventy hours, and events involving three or more units occur, on average, about once every 200 hours of travel.
- On average, a driver can expect to experience 190 to 250 (for triples and doubles, respectively) ABS braking events per 100,000 miles. Of these, twenty-five to thirty can be expected to involve two units and nine or ten to involve three or more units of the vehicle.

**Distribution of ABS events experienced in  
100,000 miles of travel by an LCV**

<i>Travel speed, mph</i>	<i>Severity, number of units experiencing ABS activity</i>		
	<i>One</i>	<i>Two</i>	<i>Three or more</i>
<i>0 to 25</i>	75	14	4
<i>25 to 45</i>	68	10	4
<i>over 45</i>	38	4	2

# ESTUDIO DE INVESTIGACIÓN DE LA UNIVERSIDAD DE MICHIGAN

Puede ser consultado en:

<http://www.hti.umich.edu/cgi/t/text/text-idx?sid=50cf84488b83cc2b8ba0554be1cc5c98;c=umtri;idno=88519.0001.001>

- ABS activity takes place about as frequently on dollies as on trailers, suggesting that, for stability in braking, ABS is as important on A-dollies as it is on trailers.

An important objective of the program was to determine conditions under which sufficient electrical power for the operation of ABS on LCVs could be provided through the brake light circuit using the conventional seven-pin connector. To this end, special modifications were made to the wiring of the tractors and the trailers used in the study in order to provide an electrical system optimized for this purpose. It was found that, even with this *special wiring and well maintained connectors*, it was necessary for the electrical systems of the tractors to supply a minimum of 13.3 volts and for the ABS on dollies and trailers to require no more than 9.0 volts in order to ensure that sufficient electrical power could be supplied. (The voltage level supplied by tractors in the study varied considerably with more than half falling below the critical value of 13.3 volts.)

Introducing ABS on all units of a typical double- or triple-trailer combination vehicle was found to increase the maintenance expense of the entire vehicle by about 1 percent. The cost of maintaining ABS on trailers and dollies appears to be about 3.2 cents per unit per one hundred miles traveled. This represents about 1 percent of the maintenance costs of a trailer and about 3 percent of those costs for a dolly. The figures for tractors are 4.5 cents per one hundred miles and 0.5 percent of the maintenance expense of the unit.

At the same time, however, ABS can lower costs incurred through tire flat spotting (which occurs when a locked wheel is dragged across the ground for an appreciable distance). Actual savings could not be established, since it was not possible to determine a reference cost for tire flat spotting experienced without ABS. However, *131 individual*

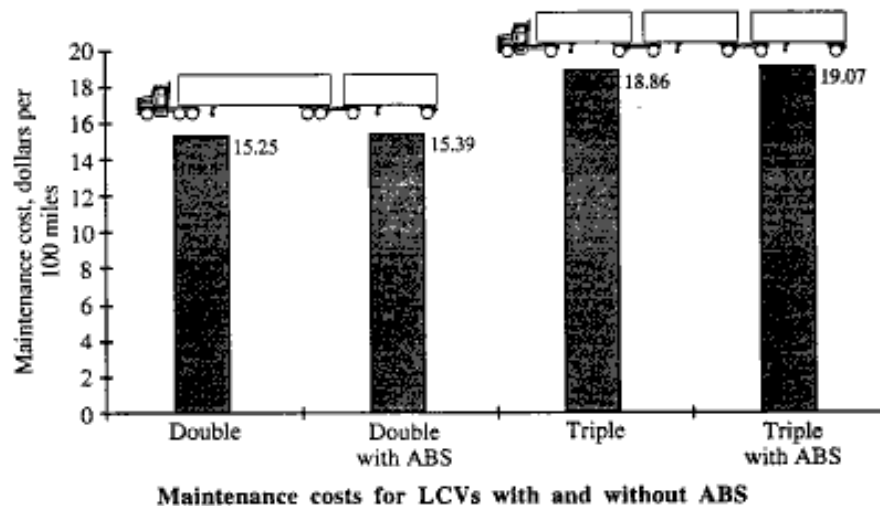

**Maintenance cost for ABS on individual units of LCVs**

Costs, dollars per 100 miles for:	Tractors	Trailers	Dollies
ABS	0.045	0.032	0.032
All other systems†	9.048	2.582	1.034
Total	9.093	2.614	1.066

† These costs do not include the expense of periodic and annual inspection on trailers and dollies.

units accumulated a total of 10.5 million unit-miles in this study without any tire flat spotting occurring in normal or emergency braking. (Frozen brakes did account for the loss of four tires to flat spotting during the study.)

**C-Dollies In The Operation Of LCVs**

Although the methodology was vastly different than in any previous work, this field study confirmed (and in some instances virtually duplicated) the findings of many previous research efforts in regards to the lateral performance qualities of LCVs. That is, this study found that C-dollies serve to improve the dynamic stability of double- and triple-trailer vehicles by reducing the rearward amplification response which these vehicles exhibit when they are equipped with A-dollies.

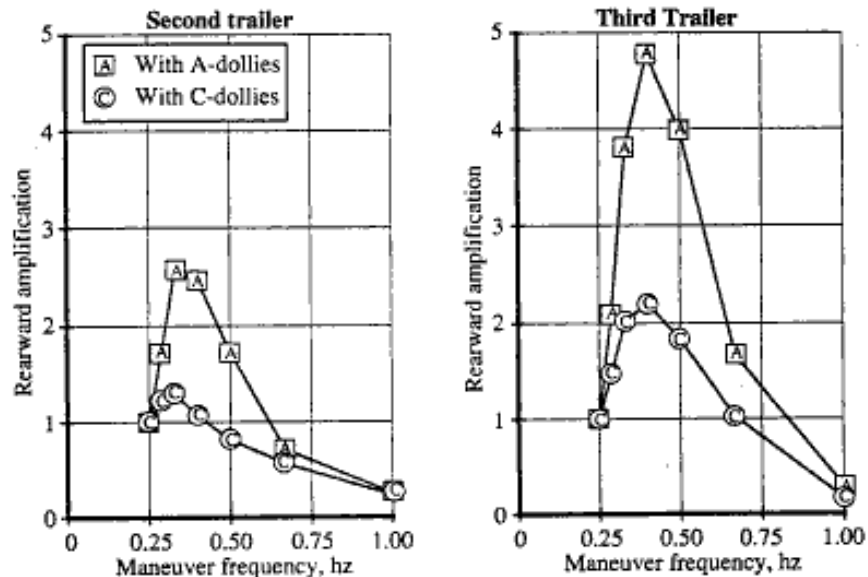

Rearward amplification measured on fully loaded triples (55-65 mph)



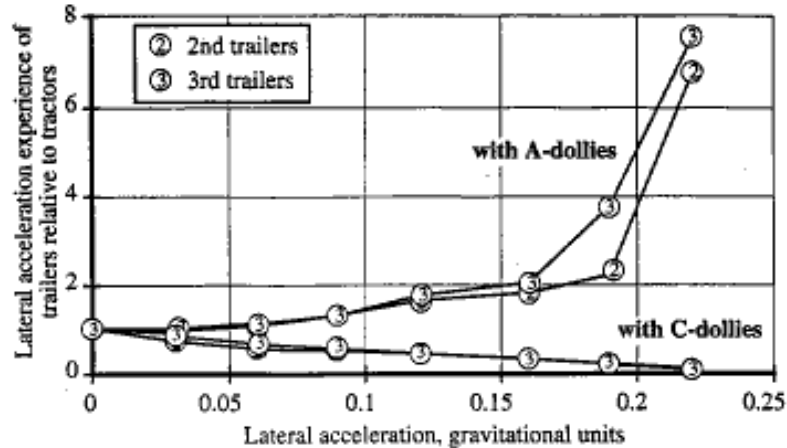

**The lateral acceleration experience of the trailers of fully loaded triples relative to their tractors (above 45 mph)**

The lateral acceleration behavior of tractors and trailers was measured with instruments on board the test fleet for approximately 350,000 miles of travel. Eighty-four percent of this travel was with LCVs equipped with C-dollies and the remainder was with A-dollies. The data were used to produce two measures of lateral behavior for comparing the performance of the A-trains and C-trains. One was the traditional measure of rearward amplification (in the frequency domain). The other was a rearward-amplification-like measure based on the ratio of the times that trailers and tractors, respectively, spent above specified levels of lateral accelerations.

When operating with A-dollies, the trailers of the LCV study vehicles tended to experience substantially larger lateral accelerations than the tractors towing them (i.e., rearward amplification). When equipped with C-dollies, this tendency was greatly reduced or reversed. The sensitivities of the rearward-amplification response to such factors as trailer wheelbase, speed, and number of trailers was generally the same in the test fleet as was found in previous work. C-dollies produced the greatest improvement in lateral behavior in those vehicles displaying the greatest rearward amplification—triples.

The data gathered in this field study provide other interesting insights into the lateral-acceleration experience of multitrailer commercial vehicles, and *perhaps* into the response of drivers to the lateral performance qualities of their vehicles. It was found that *tractors* pulling A-trains operated at higher lateral accelerations for a smaller percentage of travel time than tractors pulling C-trains. Time spent at higher lateral accelerations correlated very well to the type of vehicle and dolly. These observations should be considered as preliminary, but there appears to be evidence suggesting that drivers respond to the poorer



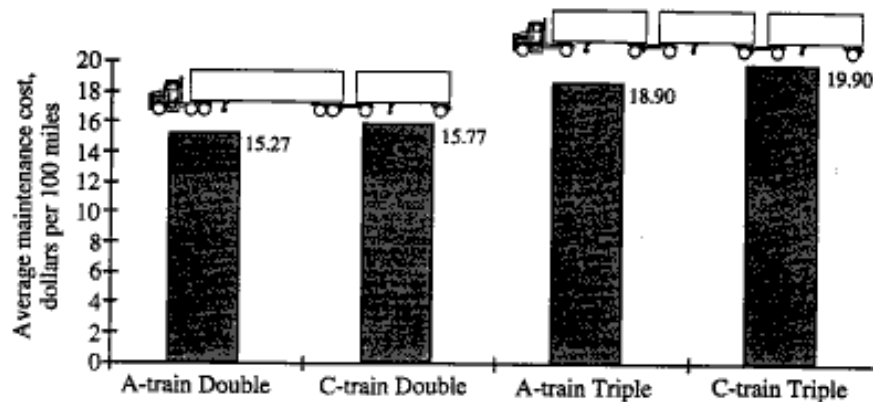

Maintenance costs for LCVs using A-dollies and C-dollies

tracking behavior of the trailers of A-trains by driving more cautiously. This is an area worthy of further study.

Replacing A-dollies with C-dollies appeared to increase the overall maintenance costs for double-trailer combinations by about 3 percent and by about 5 percent for triple-trailer combinations. Most of these increases in operating expense resulted from an 80 percent increase in tire wear rates on C-dollies relative to A-dollies. Continuing maintenance cost associated with the unique features of the C-dolly—the double tow bar and its hitches and the self-steering system—appeared minor in relation to increased tire costs. The maintenance expense for operating a single A-dolly was \$1.04 per 100 miles, of which \$0.55 was attributable to tire costs. The comparable figures for C-dollies are \$1.54 and \$0.99, respectively.

Those fleets with no previous experience with the operation of C-dollies suffered additional expenses for the repair of pintle hitches. These cost were not true maintenance expenses, but were shown to be strongly related to driver experience, declining rapidly over the driver's first few trips with C-dollies. On average, a cost of approximately \$100 was incurred for each *inexperienced* driver over his first thirty trips with C-dollies.

Maintenance cost for individual units

Costs per 100 miles for:	Tractors	Trailers	C-dolly	A-dolly
Tires	1.25	0.64	0.99	0.55
All other items <sup>†</sup>	7.80	1.95	0.55	0.49
Total	9.05	2.59	1.54	1.04

<sup>†</sup> These costs do not include the expense of periodic and annual inspection on trailers and C- and A-dollies.

Presumably, these costs could be substantially reduced with improved driver training or simplified hitching mechanisms.

#### **The Opinions Of Fleet Personnel On ABS And C-dollies In LCV Operations**

The drivers, mechanics, and fleet managers participating in the LCV field study were surveyed in order to determine their opinions regarding ABS and C-dollies. Five opinion surveys were conducted periodically throughout the field study so that the changes in opinion with exposure to this equipment could be observed. The results of these surveys reveal that:

- The opinions of fleet personnel regarding the use of ABS on LCVs are strongly positive. This is true with respect to ABS on tractors, trailers, and dollies.
- Opinions on ABS were positive at the outset of the study and tended to rise with exposure to ABS during the study.
- By the end of the one and one-half years of the study, drivers, on average, felt that ABS had helped them avoid or reduce the severity of an accident "a few times."
- The opinions of fleet personnel regarding C-dollies are generally positive.
- Drivers' opinions of C-dollies were strongly positive and were consistently the most positive among the three classifications of fleet personnel.
- In general, opinions on C-dollies held fairly consistent over the period of the study.

ESTUDIO DE INVESTIGACIÓN DE LA UNIVERSIDAD DE MICHIGAN  
Puede ser consultado en:

<http://www.hti.umich.edu/cgi/t/text/text-idx?sid=50cf84488b83cc2b8ba0554be1cc5c98;c=umtri;idno=88519.0001.001>

CONTENTS

VOLUME I - FINAL TECHNICAL REPORT

ACKNOWLEDGMENTS.....	i
EXECUTIVE SUMMARY.....	iii
CONTENTS.....	xi
LIST OF FIGURES.....	xvii
LIST OF TABLES.....	xxi
INTRODUCTION.....	1
Limitations Of The Field Study.....	2
The Structure Of This Report.....	3
AN INTRODUCTION TO TERMINOLOGY.....	5
Vehicle Configurations.....	5
Antilock Braking Systems.....	7
Converter Dollies.....	8
THE LCV TEST PROGRAM.....	11
An Overview.....	11
Description Of The Test Conditions.....	14
Vehicle Units, Configurations, And Loading.....	14
ABS Equipment.....	15
Special Vehicle Wiring And Brake Lamps.....	16
C-Dollies And Hitches.....	18
Routes.....	19
Drivers.....	20
Electronic Data Systems.....	20
Duration Of The Study And Mileage Accumulations.....	21
THE PERFORMANCE OF ANTILOCK BRAKING SYSTEMS ON LONG COMBINATION VEHICLES.....	27
ABS Activity In The LCV Study Fleet.....	27
Characterization Of The Braking Events Of LCVs Based On The Number Of Units Involved In ABS Activity.....	28
Characterization Of Braking Events Of Individual Units Based On ABS Activity Within The Unit.....	34
The Distribution Of ABS Braking Activity According To Unit Position In The Combination.....	38

ESTUDIO DE INVESTIGACIÓN DE LA UNIVERSIDAD DE MICHIGAN

Puede ser consultado en:

<http://www.hti.umich.edu/cgi/t/text/text-idx?sid=50cf84488b83cc2b8ba0554be1cc5c98;c=umtri;idno=88519.0001.001>

Powering ABS On LCVs Through The Brake-Light Circuit.....	39
Brake-Light-Circuit Voltage In Normal Braking.....	41
Brake-Light-Circuit Voltage During Braking With ABS Activity .....	43
The Influence Of Tractor Voltage On ABS Supply Voltage On Dollies And Trailers.....	45
ABS Supply Voltage In Especially Intense Events.....	50
Summary Of Findings On Powering ABS On LCVs Through The Brake-Light Circuit.....	52
Characterization Of The Longitudinal Behavior Of LCVs .....	52
Distribution Of Travel Time.....	53
Brake Applications Per Mile .....	53
Brake Application Pressure.....	55
Longitudinal Deceleration.....	57
<b>MAINTENANCE, RELIABILITY, AND OPERATING COSTS OF ANTILOCK BRAKING SYSTEMS ON LCVS.....</b>	
Summary Of The Maintenance Costs Of ABS On LCVs.....	61
The Cost Of ABS On Trailers And Dollies In Comparison To The Total Maintenance Costs Of These Units.....	63
ABS And The Flat Spotting Of Tires.....	64
Reliability, Durability, And Maintenance Costs Of ABS.....	65
Problems Related To The Design And Installation Of ABS On Trailers And Dollies.....	66
Cables and connectors.....	67
Electronic control units.....	67
Electronic control unit recall.....	68
Maintenance Of ABS On Trailers And Dollies During The Field Study.....	69
Cable and connectors.....	69
Electronic control unit .....	70
Inspection - No problem found.....	70
Modulator valves.....	71
Wheel-speed sensors.....	71
Status light.....	72
Comparison With Results Of A Previous Study Of The Maintenance Costs Of ABS On Semitrailers.....	72
Maintenance Of ABS On Tractors.....	75
Cable and connectors.....	76
Inspection - No problem found.....	76
Wheel-speed sensors.....	77
Status light.....	77
<b>THE OPINIONS OF FLEET PERSONNEL REGARDING ANTILOCK BRAKING SYSTEMS IN LCV OPERATIONS .....</b>	
Familiarity: How familiar are you with Antilock Braking Systems? .....	80

ESTUDIO DE INVESTIGACIÓN DE LA UNIVERSIDAD DE MICHIGAN

Puede ser consultado en:

<http://www.hti.umich.edu/cgi/t/text/text-idx?sid=50cf84488b83cc2b8ba0554be1cc5c98;c=umtri;idno=88519.0001.001>

Reliability: How would you rate the reliability of ABS? .....	80
Written comments.....	80
Maintenance And Use: How difficult are ABS to maintain?.....	81
Written comments.....	83
ABS Use: What is your opinion regarding ABS on tractors, trailers, and dollies?.....	83
Written Comments.....	83
Frequency Of ABS Activity: Have you ever been in an emergency situation where ABS helped you avoid or reduce the severity of an accident?.....	84
Written comments.....	84
Effect Of ABS On The Driver's Job: Do you feel the use of ABS on the entire vehicle will change your job?.....	85
Written comments.....	85
Summary Of Opinions On ABS .....	86
<b>C-DOLLIES AND THE DYNAMIC STABILITY OF LONG</b>	
<b>COMBINATION VEHICLES .....</b>	<b>87</b>
Introduction To Rearward Amplification And The Stability Of Multitrailer Trains .....	87
Measurement Of The Dynamic Stability Of The LCV Field Study Fleet .....	91
Rearward Amplifications Of The LCV Field Study Fleet—Analyses In The Frequency Domain .....	91
Rearward Amplifications Of The LCV Field Study Fleet— Implications Of The Lateral Acceleration Histograms .....	97
Qualities Of Tractor Lateral Acceleration Histograms Which May Reflect On Driver Behavior.....	103
<b>MAINTENANCE, RELIABILITY, AND OPERATING COSTS OF C-</b>	
<b>DOLLIES .....</b>	<b>107</b>
Summary Of The Maintenance Costs Of A-Trains And C-Trains .....	107
Tire Wear And Costs For A-Dollies And C-Dollies.....	108
Tire Wear For A-Dollies And C-Dollies.....	109
Tire Costs For A-Dollies And C-Dollies .....	111
Comparison Of Maintenance Costs For C-Dollies And A-Dollies.....	113
Maintenance And Reliability Of C-Dollies In This Study .....	115
Startup And Installation Problems .....	116
Problems Of Driver Training And Inexperience.....	116
Excessive Frame Costs Due To Damage Of The Jack Leg .....	120
Maintenance costs for the repair of jack legs on C-dollies in the field study.....	121
Maintenance costs for the frame system of A-dollies at fleet X.....	121
Maintenance And Reliability Of C-Dollies In The LCV Field Test.....	121
Brake system.....	122

ESTUDIO DE INVESTIGACIÓN DE LA UNIVERSIDAD DE MICHIGAN

Puede ser consultado en:

<http://www.hti.umich.edu/cgi/t/text/text-idx?sid=50cf84488b83cc2b8ba0554be1cc5c98;c=umtri;idno=88519.0001.001>

Coupling system .....	124
Electrical system .....	124
Frame system.....	126
Steering system.....	127
Trim System .....	128
Wheels System .....	128
Maintenance Costs Experienced By C-Dollies Based On Historical Records .....	128
Maintenance Costs Incurred By A-Dollies In The Field Study.....	129
Maintenance Costs Incurred By A-Dollies Based On Historical Records .....	130
Maintenance Costs For A-Dollies From Other Sources .....	131
<b>THE OPINIONS OF FLEET PERSONNEL REGARDING C-DOLLIES IN</b>	
<b>LCV OPERATIONS.....</b>	<b>133</b>
Familiarity: How familiar are you with double-drawbar C-dollies?.....	135
Reliability: How would you rate the reliability of C-dollies?.....	135
Maintenance And Use: Based on your experience with both A-dollies and C-dollies, have you found one to be more difficult to use (maintain)? .....	135
Written comments.....	136
C-dolly Use: What is your opinion of using C-dollies in double and triple combinations? .....	137
Written comments.....	137
Overall Influence: How do you feel the use of C-dollies will change your job? .....	137
Written comments.....	138
Summary Of Opinions On C-Dollies.....	138
REFERENCES.....	141
<b>VOLUME II - APPENDICES</b>	
CONTENTS.....	i
APPENDIX A. DATA FORMS .....	A-1
APPENDIX B. INSTRUMENTATION AND DATA REDUCTION .....	B-1
APPENDIX C. FLEET PERSONNEL OPINION AND COMMENTS .....	C-1
APPENDIX D. EQUIPMENT LIST AND ABS CONFIGURATIONS .....	D-1
APPENDIX E. C-DOLLY OPERATION AND SUPPLIER COMMENTS.....	E-1
APPENDIX F. FLEET ROUTES .....	F-1
APPENDIX G. DRIVER NAMES.....	G-1



ESTUDIO DE INVESTIGACIÓN DE LA UNIVERSIDAD DE MICHIGAN

Puede ser consultado en:

<http://www.hti.umich.edu/cgi/t/text/text-idx?sid=50cf84488b83cc2b8ba0554be1cc5c98;c=umtri;idno=88519.0001.001>

APPENDIX H. ABS ACTIVITY AND BRAKE-LIGHT-CIRCUIT VOLTAGE.....	H-1
APPENDIX I. BRAKE PRESSURE HISTOGRAMS.....	I-1
APPENDIX J. LONGITUDINAL ACCELERATION HISTOGRAMS .....	J-1
APPENDIX K. MAINTENANCE COSTS FOR TRAILERS AND TRACTORS, AND STANDARDIZED LABOR RATES AND PARTS COSTS.....	K-1
APPENDIX L. LATERAL STABILITY PERFORMANCE DATA .....	L-1
APPENDIX M. TIRE WEAR DIFFERENCES BETWEEN A-DOLLIES AND C-DOLLIES .....	M-1
APPENDIX N. ANALYSIS OF AN LCV ACCIDENT .....	N-1



LIST OF FIGURES

1. Combination vehicle configurations of the LCV operational field test .....	6
2. The A-dolly and the C-dolly.....	9
3. Supplemental wiring for the tractors and trailers in the LCV field study.....	17
4. Photograph of the ITR C-dolly.....	18
5. Progress of the operational field test.....	22
6. Unit-miles accumulated during the LCV field study .....	23
7. Distributions of trip miles accumulated in the LCV field study .....	24
8. The occurrence of LCV braking events according to the number of units exhibiting ABS activity during the event.....	29
9. The occurrence of LCV braking events according to loading condition and the number of units experiencing ABS activity.....	31
10. The occurrence of LCV braking events according to speed of travel and the number of units experiencing ABS activity.....	32
11. The occurrence of intraunit braking events according to the number of ABS cycles observed during the event.....	35
12. The occurrence of intraunit ABS braking events according to loading condition and the number of ABS cycles during the event.....	36
13. The occurrence of intraunit ABS braking events according to speed of travel and the number of ABS cycles during the event .....	37
14. Distribution of ABS events among the units of LCVs as a function of loading condition.....	39
15. Supplemental wiring for the tractors and trailers in the LCV field study.....	40
16. Average brake-light-circuit voltage during normal braking.....	42
17. Percentage of time during ABS braking events when the brake-light-circuit voltage was less than the indicated threshold voltage for all LCVs with incandescent brake lamps.....	45
18. Percentage of time during ABS braking events when the brake-light-circuit voltage was less than the indicated threshold voltage for LCVs with incandescent brake lamps and supply voltages greater than 13.3 volts.....	47

ESTUDIO DE INVESTIGACIÓN DE LA UNIVERSIDAD DE MICHIGAN

Puede ser consultado en:

<http://www.hti.umich.edu/cgi/t/text/text-idx?sid=50cf84488b83cc2b8ba0554be1cc5c98;c=umtri;idno=88519.0001.001>

19. Percentage of time during ABS braking events when the brake-light-circuit voltage was less than the indicated threshold voltage for LCVs with incandescent brake lamps and supply voltages less than 13.3 volts .....	48
20. ABS supply voltages and brake system pressures during an intense ABS braking event .....	51
21. Distribution of travel time by configuration and speed.....	53
22. Distribution of brake application time by configuration and speed.....	54
23. Distribution of brake applications per mile by configuration and load condition.....	55
24. Average brake application pressure as a function of speed for different load conditions.....	56
25. Average brake application pressure as a function of speed for double- and triple-trailer LCVs .....	57
26. Average longitudinal deceleration as a function of speed for different load conditions .....	58
27. Average longitudinal deceleration as a function of speed for double and triple trailer LCVs.....	59
28. Maintenance costs for LCVs with and without ABS .....	62
29. Maintenance cost rates for ABS and other systems for trailers and for dollies .....	63
30. Intervals of repairs for ABS and other trailer systems from the LCV study and a previous semitrailer study .....	64
31. Summary of maintenance cost rates for ABS components from the LCV study and the previous semitrailer study .....	73
32. Summary of ABS component repair rates from the LCV study and the previous semitrailer study .....	74
33. Frequency of maintenance incidents of ABS components for a hypothetical fleet of 100 trailers and dollies.....	75
34. Opinions of fleet personnel on ABS in LCV operations.....	81
35. The rear trailer of a western double approaching rollover in a rapid lane change maneuver.....	88

ESTUDIO DE INVESTIGACIÓN DE LA UNIVERSIDAD DE MICHIGAN

Puede ser consultado en:

<http://www.hti.umich.edu/cgi/t/text/text-idx?sid=50cf84488b83cc2b8ba0554be1cc5c98;c=umtri;idno=88519.0001.001>

36. Rearward amplification is defined as the ratio of the trailer lateral acceleration to tractor lateral acceleration and is sensitive to the period (or frequency) of the tractor maneuver.....	89
37. Rearward amplification of a loaded western double from simulations of the lane-change and pseudo-random test methods (55 mph).....	90
38. Comparison of the lateral acceleration gain (rearward amplification) measured on loaded triples of the LCV field study while equipped with A-dollies and with C-dollies (55–65 mph).....	92
39. Peak rearward amplification of short-trailer doubles and triples as a function of loading, dolly type, and speed.....	94
40. Peak rearward amplification of Rocky Mountain doubles as a function of loading, dolly type, and speed.....	96
41. The lateral acceleration experience of all vehicles in the LCV study distinguished by dolly type (speeds above 45 mph).....	98
42. The lateral acceleration experience above 0.08 g of all vehicles in the LCV study distinguished by dolly type (speeds above 45 mph).....	99
43. The lateral acceleration experience of all trailers relative to the lateral acceleration of tractors distinguished by trailer position and dolly type (speeds above 45 mph).....	101
44. The lateral acceleration experience of the trailers of triples relative to the lateral acceleration of tractors, distinguished by dolly type, loading condition, and trailer position (speeds above 45 mph).....	102
45. Comparison of the lateral acceleration experience of the tractors of triples when pulling A-dollies and C-dollies, respectively (speeds above 45 mph).....	104
46. Relative lateral acceleration experience of the tractors of loaded LCVs pulling A-dollies and C-dollies, respectively (speeds above 45 mph).....	105
47. Maintenance costs for LCVs using A-dollies and C-dollies.....	107
48. Maintenance costs for tractors, trailers, and dollies.....	109
49. Summary of the maintenance costs of all C-dollies and A-dollies in dollars per 100 miles.....	114
50. Photograph of a conventional drop-on pintle hitch (center) and the bell-mouth pintle hitches used with C-dollies in the LCV field study.....	117

ESTUDIO DE INVESTIGACIÓN DE LA UNIVERSIDAD DE MICHIGAN

Puede ser consultado en:

<http://www.hti.umich.edu/cgi/t/text/text-idx?sid=50cf84488b83cc2b8ba0554be1cc5c98;c=umtri;idno=88519.0001.001>

51. The accumulation by the Portland fleets of problems with the bell-mouth hitches used with C-dollies and of trips with C-dollies, respectively, as a function of driver experience with C-dollies.....	118
52. Problems per trip with the bell-mouth hitches used with C-dollies in the Portland fleets as a function of driver experience .....	119
53. Average accumulated costs per unit for the maintenance of the brake system of C-dollies.....	123
54. Average accumulated costs per unit for the coupling system of C-dollies .....	125
55. Average accumulated cost per unit for the maintenance of the electrical system of C-dollies .....	125
56. Average accumulated costs per unit for the frame system of C-dollies.....	127
57. Average accumulated costs per unit for the steering system of C-dollies.....	128
58. Opinions of fleet personnel on C-dollies in LCV operations.....	134

LIST OF TABLES

1. Vehicle units in the test fleet.....	14
2. ABS on the test fleet by manufacturer and configuration.....	16
3. Duration of the LCV field test.....	22
4. Expected distribution of ABS events experienced by a driver of LCVs over 100,000 miles (218 events).....	34
5. Statistics of the brake-light-circuit voltages measured in normal braking.....	43
6. ABS event times for doubles and triples using incandescent brake lamps.....	44
7. ABS event times for LCVs using incandescent brake lamps and with tractor supply voltages greater than 13.3 volts.....	49
8. ABS event times for LCVs using incandescent brake lamps and with tractor supply voltages equal to or less than 13.3 volts.....	49
9. Statistics describing brake applications per mile for different configurations and load conditions.....	54
10. Maintenance costs of ABS and other systems on LCVs.....	62
11. Maintenance costs for individual units.....	62
12. Summary of ABS maintenance problems and costs for 114 trailers and dollies.....	69
13. Summary of ABS maintenance costs for seventeen tractors.....	76
14. Positive ratings of ABS by fleet personnel.....	86
15. Regression model of the relative lateral acceleration experience of tractors.....	106
16. Maintenance cost for C-trains and A-trains.....	108
17. Maintenance cost for individual units.....	109
18. Tire wear rates for A-dollies and C-dollies.....	110
19. Tire costs for A-dollies.....	112
20. Summary of the maintenance costs of C-dollies and A-dollies in dollars per 100 miles.....	115
21. Summary of maintenance problems and costs of the C-dollies of the field study.....	122

ESTUDIO DE INVESTIGACIÓN DE LA UNIVERSIDAD DE MICHIGAN

Puede ser consultado en:

<http://www.hti.umich.edu/cgi/t/text/text-idx?sid=50cf84488b83cc2b8ba0554be1cc5c98;c=umtri;idno=88519.0001.001>

22. Summary of historical maintenance costs for C-dollies.....	129
23. Mileages of A-dollies tracked in the field study .....	129
24. Summary of the maintenance costs for the A-dollies of the study in dollars per 100 miles.....	130
25. Summary of historical maintenance costs for A-dollies in dollars per 100 miles.....	131
26. Other maintenance costs for A-dollies, dollars per 100 miles.....	132
27. Positive ratings of C-dollies by fleet personnel .....	139

## INTRODUCTION

This document is volume 1 of the final technical report of a research project entitled "LCV Operational Field Test." (Appendices appear in volume 2.) It was prepared by the University of Michigan Transportation Research Institute (UMTRI) for the National Highway Traffic Safety Administration (NHTSA) under task order number NRD-01-3-07247 of contract number DTNH22-92-D-07003 (Heavy Truck Crash Avoidance Research). This long-combination-vehicle (LCV) operational field test is one element of the LCV study mandated by the U.S. Congress in the Intermodal Surface Transportation Efficiency Act of 1991 (ISTEA). The field test was preceded by a planning study entitled "Planning to Conduct LCV Operational Test," task order number NRD-01-2-07572.[1]<sup>1</sup>

This project is the third in a series of field tests conducted by the NHTSA. The first study examined the performance of antilock braking systems (ABS) on 200 commercial vehicle tractors.[2] The second looked at ABS on fifty semitrailers.[3] This study extends the investigation of ABS into the realm of the LCV and, at the same time, investigates the performance of double-tow-bar dollies (C-dollies) on LCVs. This report refers often to the findings of the previous two field studies.

The objective of the field study, as stated by the NHTSA, was to "evaluate the stability enhancing characteristics, practicality/reliability, maintenance costs and (fleet) personnel reactions to ABS... and double-drawbar dollies." To do this, a fleet of double- and triple-trailer LCVs in *actual commercial service* was equipped with ABS and with double-tow-bar dollies and their performance was monitored for a period of approximately one and one-half years. In that time, the test fleet traveled approximately 1.4 million miles on trips within the study, and the individual units of the test fleet accumulated over 10.5 million unit-miles. Monitoring techniques included the tracking of all maintenance work done on the vehicles in the study and measurement of the physical behavior of the vehicles on the road by means of on-board instrumentation systems.

The test vehicles were distributed among five commercial fleets operating in the northwestern region of the country where the use of LCVs is most prevalent. Four of the participants were the private fleets of large, retail-chain-store companies. The fifth was a regional LTL (less-than-truck-load) carrier. Seventeen tractors, eighty-six trailers and twenty-eight C-dollies made up the test fleet. All tractors and trailers were owned by the participating fleets. The project provided the majority of the C-dollies, although one fleet operated C-dollies prior to the study. These units were equipped with ABS, special hitching hardware to accommodate C-dollies, and instrumentation systems for monitoring vehicle performance.

---

<sup>1</sup> Numbers in brackets refer to bibliographic references listed in the last chapter of this report.



### LIMITATIONS OF THE FIELD STUDY

The authors believe that the findings set forth in this report are meaningful and that they are fair representations of the performance (economic and physical) of ABS and C-dollies in the environment of the five participating commercial fleets. At the same time, however, it is important to indicate clearly that it is not possible to assign any measure of statistical certainty to the findings to be presented.

The effort and funds expended to conduct this study were substantial. Even so, the study was too small—in number of fleets, number of units, and duration in time or in miles—to yield results that could be claimed to be representative of widespread use of ABS or C-dollies. All observations were made in the northwest and are influenced by the geography, weather, and road usage laws of that region. The participating fleets have their own distinguishing characteristics of management style, products transported, etc. The majority of ABS and C-dollies were new at the outset of study and could be expected to have a normal life span of twenty years or so, but the study tracked this equipment for only one and one-half years.

Further, while the fleet of vehicles monitored in this study was, indeed, operated in *actual* commercial service, this was not precisely *normal* service because of the practical limits of costs and other realities. In the normal operations of the participating fleets, specific tractors, trailers, and dollies would not stay together as one vehicle (i.e., stay “married,” in the parlance of the trucking industry) for more than a single trip. Typically, a trailer pulled by one tractor today would be pulled by another tractor on its next trip and still another after that. Where a trailer goes next is simply a function of the immediate logistical problem faced by the company dispatcher.

However, in *field study* operations, the test equipment had to stay together for a variety of reasons: C-dollies could only be used with the trailers retrofitted with special hitches; electric power demands of ABS for *an entire train* was a major interest, and special wiring was provided for this purpose; electric power for the instruments was provided via special wiring on the test vehicles.

The choice of fleets that would participate in the field test was strongly influenced by this need to keep the test units together. The fleet operation had to be centralized around a single distribution point to which the test units would always return. In planning the study, each participating fleet identified one or two routes to dedicate to the study. The number of tractors, trailers, and dollies outfitted for the study was defined by the companies' views of the equipment needed to service those routes. These restrictions on their normal operations were a logistical burden to the companies and clearly resulted in trailers and dollies being underutilized during the study in comparison to normal service. (However, the restrictions were not absolute. Field study equipment did get used outside the program. Tractors,

especialmente, acumulados muchos kilómetros en combinación con remolques y carretillas que no fueron parte del estudio.)

Hay otros, mucho más subjetivos elementos del estudio, que no son *normales* y que pueden haber tenido algún efecto en los resultados. Uno de estos involucra motivación. Aunque es cierto que todas las flotas participantes fueron muy cooperativas (y los autores son muy agradecidos por eso), también es cierto que todos los voluntarios pertenecían a otra flota. La decisión de usar ABS y de usar C-carretillas fue de alguien más, no de ellos. El capital invertido en ABS y en C-carretillas fue de alguien más, no de ellos. La participación fue un compromiso temporal, no permanente. En consecuencia, en algunos casos, el compromiso diario de "hacer que funcione" puede no haber sido el mismo que el resultado de una decisión interna de usar esos productos.

Es también probable que los procedimientos de mantenimiento de las flotas fueron alterados de su situación normal por el estudio. En orden de rastrear los costos de mantenimiento, se introdujeron reportes no estándares y procedimientos de mantenimiento que pueden haber traído un nivel de atención más alto a los equipos de estudio. En orden de agilizar el programa, el proyecto tuvo su propia oficina en el campo, moviéndose entre las flotas durante el programa. La condición inusual de propiedad y financiamiento de los equipos alteró la relación entre las flotas y los proveedores, probablemente disminuyendo la agresividad de las flotas al buscar el servicio de garantía. Los fabricantes de los ABS y C-carretillas fueron conscientes del estudio—y que era financiado federalmente, y que los resultados serían hechos públicos. Esto también puede haber tenido alguna influencia en los procedimientos de mantenimiento y en las relaciones entre las flotas y los proveedores.

El efecto neto de todos estos elementos no puede ser cuantificado. Al final, los autores solo pueden reafirmar su creencia de que la información en este reporte es una útil adición a la base de conocimientos sobre las operaciones de LCVs en general y sobre el uso de ABS y C-carretillas en particular.

### THE STRUCTURE OF THIS REPORT

Este reporte está estructurado primero para transmitir los hallazgos de la prueba de campo de LCV (en oposición a relatar el desarrollo del estudio). Como consecuencia, seis de los nueve capítulos que siguen esta introducción lo hacen, de hecho, reportando hallazgos. De estos seis capítulos, tres abordan ABS y tres abordan C-carretillas. En cada caso, un capítulo reporta sobre "las características mejoradas" del sistema y se basa principalmente en los datos electrónicos recopilados por los sistemas de instrumentos montados en los vehículos de estudio. Un segundo capítulo reporta sobre "practicidad/confiabilidad, costos de mantenimiento" como se determinó a partir de los registros de mantenimiento de la flota, y una variedad de reportes enviados por conductores, mecánicos, y otros. El tercer capítulo de cada grupo reporta "reacciones del personal de la flota" como se reveló a través de encuestas tomadas durante el estudio de campo.

## ESTUDIO DE INVESTIGACIÓN DE LA UNIVERSIDAD DE MICHIGAN

Puede ser consultado en:

<http://www.hti.umich.edu/cgi/t/text/text-idx?sid=50cf84488b83cc2b8ba0554be1cc5c98;c=umtri;idno=88519.0001.001>

The two chapters immediately following this introduction are ancillary, however. The first defines and discusses some of the peculiar jargon used throughout this document. The next chapter presents a brief overview of the field study. This is done primarily to build a context for the findings that follow. The final chapter of this volume lists the bibliographic references. More detail on the conduct of the study and voluminous presentations of data are confined to the thirteen appendices, which appear in volume 2 of this report.

## AN INTRODUCTION TO TERMINOLOGY

This chapter is presented for the reader who is not familiar with common terminology used by the U.S. trucking industry. Definitions and, where appropriate, very brief discussion of some of the jargon (and abbreviations) used throughout this document are presented.

### VEHICLE CONFIGURATIONS

This study is concerned with long *combination* vehicles. A *combination* vehicle is made up of more than one individual vehicle *unit*. The three most common types of units are tractors, semitrailers, and converter dollies. The 5-axle tractor-semitrailer is, by far, the most common combination vehicle. This study, however, is concerned only with combinations which include two or three semitrailers.

Sketches of common, multitrailer vehicle combinations appear in figure 1. Some of the associated terminology follows.

*A-train*. A multiple-trailer vehicle combination that uses A-dollies to support the front of the second and, possibly, third trailers.

*C-train*. A multiple-trailer vehicle combination that uses C-dollies to support the front of the second and, possibly, third trailers.

*Long combination vehicle (LCV)*. A commercial vehicle with two or more trailers whose combined length (of the trailers) is greater than that of two 28-foot trailers and whose gross combination vehicle weight (GCVW), with tractor, is greater than 80,000 pounds.

Combination vehicles with two 28-foot trailers and weighing up to 80,000 pounds are allowed in every state by act of the U.S. Congress. Combinations larger than this reference vehicle are called LCVs. In this document, and in common usage, a vehicle is considered an LCV if it meets the length requirement and its legally *allowable* GCVW exceeds 80,000 pounds, regardless of the *actual* gross weight of the vehicle at any given moment.

**Note:** The fleet of test vehicles followed in this study was nominally composed of Rocky Mountain doubles and triples. However, many of those vehicles nominally designated as triples actually operated a substantial portion of the time as western doubles, particularly in the winter months. This was the result of legal restrictions as well as the internal policies of some of the participating fleets. Even though western doubles are not strictly LCVs, the data gathered in this configuration are included in all the analyses and

results presented herein. Consequently, in this report, the term LCV also includes western doubles.

*Rocky Mountain double (Rockies).* A commercial vehicle composed of a tractor, one long trailer (typically thirty-five feet or longer) and one short trailer (typically twenty-seven to thirty-one feet long). This configuration was so named because of its popularity in the Rocky Mountain states.

**Rocky Mountain double**

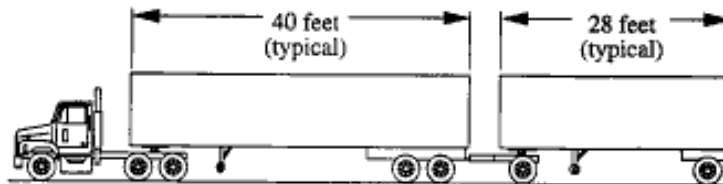

**Reverse Rocky Mountain double**

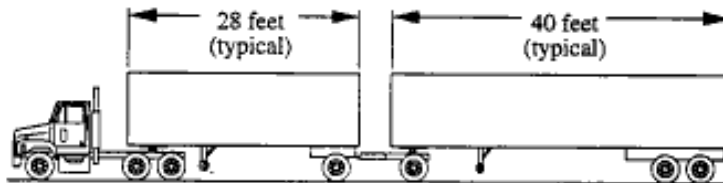

**Triple**

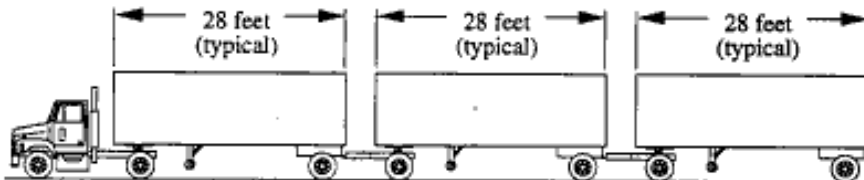

**Western double**

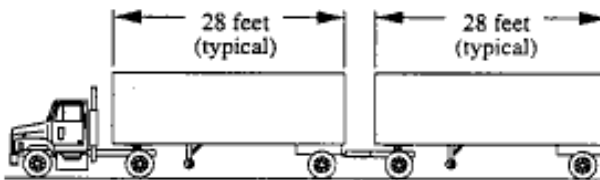

Figure 1. Combination vehicle configurations of the LCV operational field test

Typically, Rocky Mountain doubles are configured with the long trailer in the lead position. Occasionally, however, the trailer positions are reversed. In this report, Rockies in which the short trailer is in the lead position are referred to as *reverse Rockies*.

*Triples*. A commercial vehicle composed of a tractor and three short trailers (typically twenty-seven to thirty-one feet long).

*Western double*. A commercial vehicle composed of a tractor and two short trailers (typically twenty-seven to thirty-one feet long). Originally used in the western states, this vehicle is now allowed in all states.

## ANTILOCK BRAKING SYSTEMS

Antilock braking systems (ABS) are intended to prevent the complete lockup of wheels during heavy braking or braking on low-friction surfaces. The controllability and stability of all highway vehicles is dependent on the properties of the rolling tire. When a wheel locks (i.e., ceases to rotate), its tire loses lateral traction. If the front tires lock, the vehicle is no longer steerable and will continue in the direction it is headed regardless of driver steering activity. If rear tires lock, the vehicle may become unstable and spin out (either tractor or trailer, in the case of combination vehicles).

*Tire flat spotting* is the term applied to the excessive wear which occurs in one spot on the tire when a locked wheel is dragged across the ground for an appreciable distance. A single event of this type may result in sufficient wear to require the replacement of the tire. One of the acknowledged benefits of ABS is the reduction of costs associated with premature tire replacement necessitated by flat spotting.

ABS constantly monitor the rotational velocity of the wheels during braking. When wheels are seen to be approaching lockup, the driver's brake control inputs are momentarily overridden and the brakes are released as necessary to keep the tires rolling.

*Electronic control unit (ECU)*. This is the computer "brain" of the ABS. It receives signals describing the rotational speeds of the wheels from wheel-speed sensors, and sends appropriate control signals to the modulator valves which control brake actuation air pressure.

*Modulator valves*. The air-pressure control valves that can override the air pressure delivered by the standard brake system to reduce actuation pressure and prevent wheel lock.

*System configuration*. ABS for tractors and trailers come in a variety of configurations typically designated by the number of wheel-speed sensors and the number of modulators in the system. For example, a 4S2M system would have four sensors

and two modulator valves. Appendix D briefly describes and lists the configurations of the systems used in this study.

*Wheel-speed sensors.* The magnetic sensor that sends an electrical signal to the ECU which is indicative of the rotational speed of the wheel. The wheel must be equipped with a tooth ring called an *exciter ring*. The sensor is mounted close to the ring and reacts to the passage of each tooth, producing a pulsating electrical signal.

Providing electrical power to ABS on LCVs was a subject of major interest in this study. Thus, there is a great deal of discussion regarding the components of vehicle wiring, especially the components of the wiring between the individual units of the combination vehicle. By standardized conventions interunit electrical connections involve seven electrical circuits: (1) ground, (2) clearance/side-marker/identification lamps, (3) left-turn-signal/hazard lamps, (4) stop lamps/ABS, (5) right-turn-signal/hazard lamps, (6) tail-light/clearance/side-marker/license lamps, and (7) auxiliary.[4,5,6,7] Hardware elements involved in interunit wiring include:

*Seven-wire jumper cable.* The seven-wire electrical cable used to make the electrical connection between units when assembling a combination vehicle. The cable has a seven-pin connector on at least one end. The other end may be permanently attached to a unit (usually a tractor or dolly) or may also have a connector.[8] Cables come in different versions with wire gages selected for lighter (single-trailer, non ABS) or heavier (multiple-trailer and/or ABS) duty.

*Seven-pin connector.* A connector of standardized geometry used on the seven-wire jumper cable.

*Seven-pin receptacle.* A receptacle of standardized geometry intended to mate with the seven pin connector.

Virtually all semitrailers have such a seven-pin receptacle at the front bulkhead for connection to the tractor or other towing unit. Trailers used in double- or triple-trailer service typically have a second receptacle at the rear. Tractors may have such a receptacle behind the cab or may have a permanently installed jumper cable.[8] Dollies, if fitted with electrical gear, usually have two permanently installed jumper cables, one to connect to the towing trailer and one for the towed trailer. Otherwise, a seven-wire cable may be connected directly from the rear of one trailer to the front of the next, bypassing the dolly.

## CONVERTER DOLLIES

A converter dolly, or simply a dolly, is used to support the front end of a semitrailer when it is used as the second or third trailer of a combination vehicle. The semitrailer has suspension and wheels of its own only in the rear. Its forward end must be supported by other means, most typically by the rear of a tractor. When the semitrailer is used as the



second or third trailer it must be *converted* to a *full trailer* (which has suspension and wheels at both ends) by the use of a *dolly*.

Converter dollies typically have one axle, but may have two. (All dollies in this study had single axles.) Dollies are equipped with a fifth-wheel coupler directly above, and slightly forward of the suspension center. This is the coupling to the semitrailer that the dolly supports and tows.

Depending on design style, dollies may have a single- or double-tow-bar arrangement for coupling to the towing trailer. In either case, the tow bars terminate in a simple, rugged *towing eye*. The towing trailer is equipped with one or two *pinle hitches* consisting of a hook and locking mechanism which engages and secures the eye(s), thereby supporting and towing the dolly.[9]

Two types of converter dollies, which are distinguished by the number of tow bars, are illustrated in figure 2.

*A-dolly*. The defining quality of the A-dolly is its single-point tow bar. The A-dolly is the most common type of converter dolly; over 99 percent of the dollies in use in the U.S. are of this type. The single hitching point allows the dolly to articulate in yaw (steering), pitch (fore/aft rotation), and roll (side-to-side rotation) with respect to the towing trailer.

*C-dolly*. The defining quality of the C-dolly is its double-tow-bar configuration. The C-dolly (previously called the B-dolly for reasons too involved to explain here) originated in New Zealand and has found its greatest popularity in Canada. Its attractive quality is its ability to improve the stability of multiple-trailer combination vehicles. This is accomplished because the double-tow-bar hitching arrangement eliminates yaw and roll articulation with respect to the lead trailer. Eliminating yaw, in particular, can degrade low-speed maneuverability and produce excessive hitch

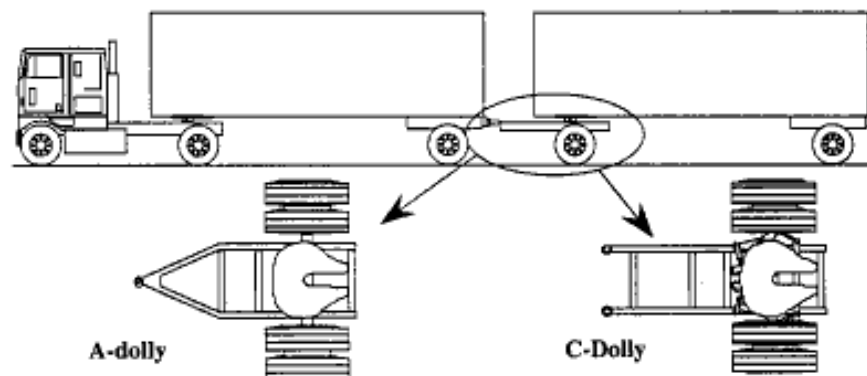

Figure 2. The A-dolly and the C-dolly

forces and tire scrubbing during tight turns at low speeds. To mitigate these low-speed problems, the wheels of the C-dolly are allowed to steer by a caster mechanism. However, a centering mechanism provides mechanical resistance to this self-steering action as required for dynamic stability at highway speeds.

*Tow bar.* The forward structure of the dolly is referred to as the tow bar. It terminates in one or two tow-bar eyes which are simple rugged steel rings for attaching to the pintle hitch.[9]

*Pintle hitch.* One (for A-dollies) or two (for C-dollies) pintle hitches are mounted to the rear of the trailer which tows the dolly.[9] The hitch consists of a rugged hook which engages and supports the tow-bar eye and a locking mechanism which ensures that the eye stays in place. A single hitch and eye results in a joint that allows articulation in all directions.

## THE LCV TEST PROGRAM

### AN OVERVIEW

The test operations of the LCV field study were conducted in the northwestern region of the country for the obvious reason that this is the center of LCV use. The test fleet was distributed among five commercial truck fleets based in Portland, Oregon, and Boise, Idaho, and operating in the states of Washington, Oregon, Idaho, Nevada, and Utah.

All five of these contiguous states allowed the use of Rocky Mountain doubles on a designated highway system. Four of the five, excluding Washington, allow operation of triples on a somewhat more restricted network. In virtually all cases, operation of these vehicles requires a special permit granted by the state. The individual states place various restrictions on the operation of triples under adverse conditions including wet or snow-and-ice-covered roads, poor visibility, and certain periods of high traffic density. Oregon is particularly strict in this regard.

The participating fleets were chosen on the basis of the suitability of their operations to the needs of the field study and, of course, their willingness to participate. The tractors and trailers owned by the fleets and chosen for participation in the study were specially equipped with ABS, C-dolly hitches, instrumentation systems, and special wiring to provide electrical power for the ABS and instruments. Financial considerations limited the number of units that could be fitted out in this manner. For the purposes of the study, these units had to be operated together as LCVs and be kept isolated from other units to the maximum extent possible. To accommodate this need, the general plan called for operating the study vehicles on specific service routes that were centralized around a single distribution center within each commercial operation. Only units equipped for the study were to make up the vehicles servicing these routes. The specific number of tractors, trailers, and C-dollies participating in the study was defined by the companies' views of their equipment needs to service these routes in the prescribed manner.

The five fleets who met the needs of the study and agreed to participate were:<sup>2</sup>

**Albertsons**, a grocery chain with a distribution center in Portland

**Fred Meyer/Distribution Trucking Company**, a grocery/discount department store chain with a distribution center in the Portland area

**PayLess Drug Stores/PLXpress** (later Thrifty PayLess, Inc.), a drug store chain with a distribution center in the Portland area

---

<sup>2</sup> The five participating fleets are referred to by name in this chapter. In other chapters, however, names are generally removed in an attempt to protect the proprietary interests of the companies.

**ShopKo Stores/SVS Trucking**, a discount department store chain with a distribution center in Boise

**Silver Eagle**, a regional common carrier with a distribution center in Portland

These five fleets operated seventeen "vehicles" for the LCV study, seven Rocky Mountain doubles and ten triples.<sup>3</sup> Vehicles appears in quotes since its definition here is a bit special: A vehicle is the collection of tractors, dollies, and semitrailers that service a single route within a fleet's operation. While only one tractor is required for this, extra trailers and dollies are generally needed. The best example is a triple-trailer "vehicle." In a typical scenario, this vehicle would service three stores and use nine trailers to do so. Each store requires the simultaneous use of three trailers. At any particular moment, one of these trailers is at the distribution center being loaded with goods for the store; one is on the road en route to the store; the third is at the store being unloaded and perhaps loaded with return goods. This "vehicle" of one tractor and nine trailers also requires at least two, and probably fractionally more, dollies to accommodate operational logistics. Through a number of variations on scenarios such as this, the seventeen vehicles of this study were composed of 131 individual units: seventeen tractors, twenty-eight C-dollies, and eighty-six semitrailers. Depending on the fleet's operations, a single vehicle made from one to five trips a week, ranging from 350 to 1500 miles per trip.

Among the five fleets, one had used C-dollies prior to the field test, three had used ABS on all their tractors, and one had used ABS on selected dollies or trailers. Thus, a major task early in this study was the acquisition of ABS and C-dolly equipment and the retrofitting of the test vehicle units with this hardware. The project also acquired and installed the instrumentation packages and the associated data-transport systems needed to monitor vehicle performance over the test period. The retrofitting task involved fitting ABS to tractors, trailers, and dollies; strengthening the frame at the aft end of trailers and installing the dual pintle hitches required for C-dollies; installing the instrumentation packages, including transducers, wiring harnesses and data loggers; and substantially modifying the wiring of the ground, brake-light, and auxiliary circuits on tractors and trailers to provide power to the ABS and instrument systems.

The retrofitting and instrumentation of the test vehicles introduced a number of partners into the study. ABS were acquired from the three primary U.S. suppliers: Allied Signal/Bendix,<sup>4</sup> Midland-Grau, and Rockwell WABCO. C-dollies and associated hitching hardware were procured from the only U.S. supplier that had produced a significant

<sup>3</sup> The vehicles nominally designated as triples actual operated a substantial portion of the time as western doubles, particularly in the winter months. This was the result of legal restrictions as well as the internal policies of some of the participating fleets. Even though western doubles are not strictly LCVs, the data gathered in this configuration is included in all the analyses and results presented herein. Consequently, in this report, the term LCV also includes western doubles.

<sup>4</sup> The company, Allied Signal, markets ABS under the Bendix brand name. The distinction between the name of the company and the name of the product is maintained in this document.

## ESTUDIO DE INVESTIGACIÓN DE LA UNIVERSIDAD DE MICHIGAN

Puede ser consultado en:

<http://www.hti.umich.edu/cgi/t/text/text-idx?sid=50cf84488b83cc2b8ba0554be1cc5c98;c=umtri;idno=88519.0001.001>

number of C-dollies, Independent Trailer & Repair (ITR). Besides their role as hardware suppliers, these companies provided training, service, and technical expertise throughout the study.

Vehicle Monitor Corporation (VMC) supplied the instrumentation systems. Instrumentation packages belonging to the government and used in previous ABS studies were substantially modified as required for this new application.[2,3] VMC was also a continuing partner, providing training, equipment maintenance, and data monitoring services. Vehicle modification and instrumentation was accomplished at Wisconsin Peterbilt in Green Bay (near the home office of ShopKo Stores), at Portland Freightliner in the city of Portland (ABS installation on two tractors), at Fruehauf Trailer Corporation in Portland, and at Western Trailer Service in Boise. Retrofitting of ABS and C-dolly hitching hardware was completed by the end of October 1993. Because the instrumentation systems had to be developed and fabricated during the project, they were not fully installed and operational until May of 1994.

Prior to launching operations of the test fleet, day-long training sessions were held for the drivers, mechanics, and management personnel of the participating fleets. One session was held in Boise for the ShopKo personnel. Two other sessions were held in Portland for personnel from the other four fleets. Training manuals unique to each fleet were prepared and distributed. Representatives of the ABS and C-dolly suppliers attended and participated as appropriate. ABS, C-dollies, and hitching hardware were on hand for demonstration and practice.

Test fleet operations were launched between August and November of 1993. The performance of the test fleet was monitored for sixty-nine (Albertsons) to eighty-four (ShopKo Stores) weeks. Over this time, data were gathered in several formats, namely:

- *Driver trip forms.* These forms were filled out and submitted by drivers for each trip. They contained information on vehicle identification, routing, loading condition, weather and road conditions, problem reports, and comments. (See appendix A.)
- *Electronic data.* Also gathered trip-by-trip, these data came from the instruments and data loggers mounted on each vehicle unit. These data included histograms of longitudinal and lateral acceleration and brake application pressures, recordings of ABS supply voltage (brake-light circuit voltage), and continuous recordings of various response variables during significant ABS and lateral events. (See appendix B.)
- *Equipment maintenance records.* All records of maintenance activity on each of the 131 units in the study were collected monthly over the course of the study. The same was done for sixteen additional A-dollies distributed across the five fleets. Also, historical maintenance records provided by some of the fleets were used in the study.

- *Tire tread depths and odometer or hubometer readings.* These data were gathered monthly from each of the 131 units by the project field representative.
- *Problem report forms.* These forms were used to document ABS and C-dolly problems and the related corrective actions. They included information provided by fleet personnel, the project field representative, and the equipment suppliers. (See appendix A.)
- *Opinion surveys.* Drivers, mechanics, and managers of the participating fleets were surveyed periodically throughout the study to obtain their opinions on ABS and C-dollies in LCV operations. (See appendix C.)

## DESCRIPTION OF THE TEST CONDITIONS

### Vehicle Units, Configurations, And Loading

In many of the presentations of the following chapters, results are given for all four types of LCVs (triples, western doubles, Rockies, and reverse Rockies), respectively. In other cases, data for normal and reverse Rockies or for the three types of doubles are pooled and results are presented in composite forms.

The analyses of later chapters also distinguish among loading conditions. Each segment of an LCV trip was segregated into one of three load conditions, namely: empty, full, or mixed. In most cases, the mixed load condition implies that some trailers were loaded and some were empty, as opposed to individual trailers being partially loaded. In a mixed load condition, the common practice among LCV fleets is to position the trailers in the train such that the fully loaded trailers are forward of the empty trailers.

Table 1 describes the distribution of the 131 vehicle units of the field test by type of unit and operating fleet. A more complete description of the individual units appears in appendix D. The following discussion briefly describes the configurations operated by the several fleets and their typical loading conditions.

Table 1. Vehicle units in the test fleet

Fleet	Tractors	Trailers		C-Dollies	Total
		Long	Short		
<i>Albertsons</i>	3	3	3	3	12
<i>Fred Meyer</i>	3		11	6 <sup>†</sup>	20
<i>PayLess</i>	2	2	8	4	16
<i>ShopKo</i>	7	9	28	9 <sup>†</sup>	53
<i>Silver Eagle</i>	2		22	6	30
<i>Total</i>	17	14	72	28	131

<sup>†</sup> Two C-dollies were transferred from Fred Meyer to ShopKo late in 1994 changing these figures to 4 and 11, respectively.

ESTUDIO DE INVESTIGACIÓN DE LA UNIVERSIDAD DE MICHIGAN  
Puede ser consultado en:

<http://www.hti.umich.edu/cgi/t/text/text-idx?sid=50cf84488b83cc2b8ba0554be1cc5c98;c=umtri;idno=88519.0001.001>

*Albertsons* operated Rocky Mountain doubles exclusively in this study. These vehicles used a 40-foot, tandem-axle trailer in combination with a rather unusual 24-foot, *tandem*-axle trailer. The average gross combination weight (GCW) of these vehicles outbound from the distribution center was 93,433 pounds. The vehicles always returned with the same trailers and were typically fully loaded in the backhaul.

*Fred Meyer* operated a mix of 31-foot and 27-foot trailers in western-doubles and triples configurations. Eighty-three percent of their trips were taken in the western-double configuration and the remaining 17 percent as triples. The average GCW outbound was 81,554 pounds for the doubles and 98,195 pounds for the triples. Return legs were typically empty and with the same trailers.

*PayLess* ran Rockies composed of 35-foot tandem-axle and 27-foot single-axle trailers in 57 percent of their field test trips. The same trailers ran as reverse Rockies in 22 percent of their trips. The 27-foot trailers were used as western doubles in 5 percent of their trips and in triples for the remaining 16 percent of trips. Average GCWs for those configurations departing from the distribution center were 67,672 pounds, 67,146 pounds, 59,010 pounds, and 83,059 pounds respectively. Return runs, using the same trailers, were typically empty.

*ShopKo* ran 44-foot tandem- and 28-foot single-axle trailers in Rockies on their northern route to Coeur d'Alene, Post Falls, and Spokane. On their southern route to Reno Nevada, they operated the 28-foot trailers as triples. Average outbound GCWs were 83,615 pounds and 97,056 pounds, respectively. Western doubles were run on the Reno route when weather conditions were adverse, with average GCW of 73,891 pounds. The northern route accounted for 55 percent of all trips and triples to Reno accounted for 40 percent, with the remainder being doubles to Reno. ShopKo tractors typically dropped off the outbound trailers and returned with different trailers (i.e., different individuals but of the same configuration). Return runs were usually empty. The runs to the north typically involved shuttling single trailers from Coeur d'Alene or Post Falls into Spokane.

*Silver Eagle* ran 28-foot doubles for 60 percent of their field test trips, with an average GCW of 57,705 pounds. Triples, also with 28-foot trailers, made up the remaining test trips, with average GCW of 77,120 pounds. Return runs, with different trailers, were typically empty or very lightly loaded. Silver Eagle loads were generally lighter than those at the other test fleets and trailer scheduling more difficult (with frequent use of trailers other than those specially prepared for the study) because they are a common carrier fleet.

#### **ABS Equipment**

The distribution of ABS brands among the trailers and dollies of the fleet was a compromise balanced representation of the ABS suppliers according to market share, and



**Table 2. ABS on the test fleet by manufacturer and configuration**

<i>Fleet</i>	<i>Tractors</i>	<i>Trailers</i>	<i>Dollies</i>
<i>Albertsons</i>	RW-4S4M	B-2S1M	B-2S1M
<i>Fred Meyer</i>	RW-4S4M	B-2S1M; MG-2S1M	B-2S1M; MG-2S1M
<i>PayLess</i>	RW-4S4M	MG-2S1M	MG-2S1M
<i>ShopKo</i>	RW-4S4M	RW-4S2M, 2S2M	RW-2S1M
<i>Silver Eagle</i>	RW-4S4M	RW-2S2M	RW-2S1M

B = Bendix; MG = Midland-Grau; RW = Rockwell WABCO; S = sensor; M = modulator

the preferences of the individual fleets. Table 2 outlines the brand and configurations of ABS used on the test fleet. Appendix D includes this information for each individual unit.<sup>5</sup>

Three trailers were new at the start of the study and were equipped with ABS at our request. The remaining eighty-three were retrofitted with ABS for the project. Twenty-two of the twenty-eight C-dollies were new and had ABS installed by the manufacturer. ABS were retrofitted to the remaining six.

ABS on fifteen of the seventeen tractors in the study were factory installed. Four of these were previously operated by the fleets. The other eleven were new and had ABS installed either as the fleets' preference or at the expense of the project. The remaining two tractors had ABS retrofitted for the project.

#### Special Vehicle Wiring And Brake Lamps

An issue of some interest to this project was whether it is feasible to power ABS on LCVs via the brake-light circuit. (This approach was under consideration as a backup power source for trailer ABS powered by a separate circuit.) The concern is whether sufficient voltage can be supplied to the rear trailers and dollies under the condition of the high current flow implied by powering both ABS and brake lamps for many units through a single circuit. The philosophical approach in this study was to determine if sufficient power could be supplied with "optimum" wiring, but with the conventional seven-pin connector used in the industry today to make electrical connections between units.

Consequently, during the retrofitting process, the wiring of tractors and trailers was modified as illustrated in figure 3. All tractors were equipped with heavy gage wiring for the ground and brake-light circuits feeding the seven-wire jumper cable to the trailers. Brake-light circuits were modified such that brake-light power was provided to the trailers through a high-capacity power relay, rather than directly through the brake-light switch. On the trailers, the existing wiring was supplemented with heavy gage wiring for ground and brake-light circuits. The new wiring ran from the front to the rear junction box of the trailers, and power was provided to the ABS via this wiring. The existing trailer circuits

<sup>5</sup> The report on the first of the series of ABS field studies conducted by NHTSA includes an extensive review of ABS applications on commercial trucks.[2]

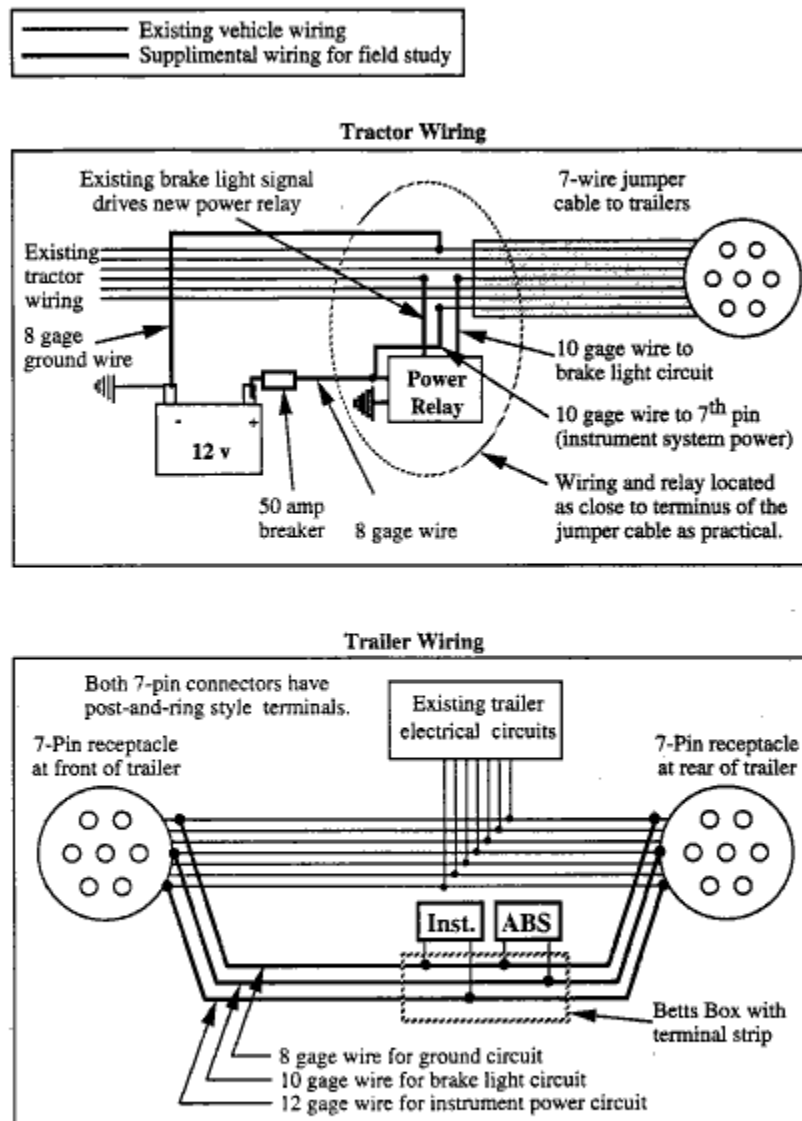

Figure 3. Supplemental wiring for the tractors and trailers in the LCV field study

were left intact. All trailers were equipped with new, seven-pin connector sockets front and rear, and all the seven-way jumper cables used in the study were of the heavy duty type.[5]

Finally, all the C-dollies and test trailers of the PayLess fleet were equipped with LED (light-emitting-diode) stop lamps. This type of lamp requires far less electrical current than incandescent lamps. Lower current draw for the lamps implies higher voltages available to power ABS on the rearward units of the train. PayLess operated both Rockies and triples, allowing the evaluation of this technology in both configurations.

#### **C-Dollies And Hitches**

All the C-dollies used in this study were manufactured by Independent Trailer and Repair (ITR) of Yakima, Washington. A photograph of an ITR C-dolly appears in figure 4, and more information on the dolly is presented in appendix E. While there are several Canadian manufacturers of C-dollies, ITR is the only significant U.S. supplier in terms of number of units produced.

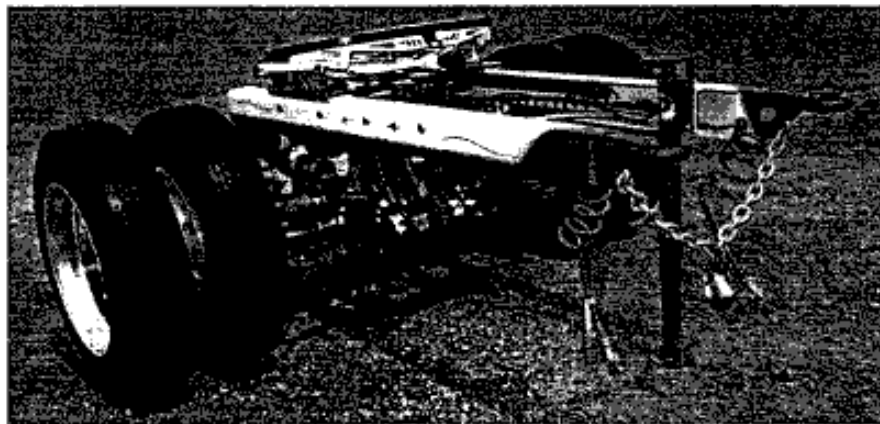

**Figure 4. Photograph of the ITR C-dolly**

Six of these C-dollies existed in the ShopKo fleet prior to the study. Three new dollies ordered by ShopKo shortly prior to the study were also included. These dollies were all specified by ShopKo and were nominally ITR's standard product. The remaining nineteen dollies were purchased for the test. Details of the specifications for these dollies were established with the cooperation of the fleets, but, at UMTRI's request, all these dollies were built in accordance with the requirements of Canadian government regulations regarding the performance of the self-steering system.[10,11]<sup>6</sup> In practice, this meant that the resistance to self-steering in these dollies was some 25 percent greater than in ITR's

<sup>6</sup> The Canadian C-dolly regulation also includes requirements for frame and hitch stiffness and strength which were not included in the specifications for dollies for this program.

standard product. Other specifications such as tongue lengths, tire brands, and other details varied among the fleets.

ITR was also the supplier of all the pintle hitches used with C-dollies in this project. ITR also worked with each fleet to specify and execute the necessary strengthening of the rear frame of their trailers as needed to withstand the increased hitch loads inherent with C-dollies. Unlike A-dolly operations, which typically employ a *drop-on* style of pintle hitch, the pintle hitches supplied for the C-dolly operations of the field study were of the *bell-mouth* variety in which the tow eye is intended to engage the hitch straight in on a horizontal course. More details on the ITR hitch are presented in appendix E.

### Routes

A detailed review of the routes covered by the vehicles in the field study appears in appendix F. The outbound destination is given for each trip and a map showing the primary destinations is included. A subjective description of the major routes is provided in a text prepared by the project field representative who rode along on selected trips.

*Albertsons'* trips depart from their distribution center in eastern Portland near routes I-84 and I-205. The majority of Albertsons' trips (56 percent) were via I-84, U.S. 395 and I-90 from Portland to Spokane, Washington and Coeur d'Alene, Idaho. Another 17 percent were on I-5, north as far as Bellingham, Washington, and south as far as Ashland, Oregon. Ten percent were into the Central Valley of Washington, via I-84, I-82, and U.S. 97.

*Fred Meyer's* distribution center is in Clackamas, Oregon, a suburb south of Portland. Seventy-four percent of their trips left Clackamas southbound to Roseburg and Grants Pass, Oregon, via I-5. Another 20 percent were from Clackamas to Bend, Oregon, via U.S. 26 and U.S. 97.

*PayLess* operated three principle routes from their distribution center in Wilsonville, Oregon (also south of Portland). These routes were:

- I-5 north as far as Blaine, Washington, and south as far as Grants Pass, Oregon, accounting for 27 percent of all trips
- I-84/U.S. 395/I-90 to Spokane, Washington, and Coeur d'Alene, Idaho, accounting for 30 percent of all trips
- I-84/I-82/U.S. 97 or I-84/I-82/U.S. 395 into Washington's Central Valley, accounting for 29 percent of all trips

*ShopKo* ran two routes from their distribution center in Boise, Idaho. Fifty-five percent of their trips ran north on U.S. 95 to Coeur d'Alene and then west on I-90 to Post Falls, Idaho and Spokane, Washington. The remaining 45 percent of their trips were southbound to Reno, Nevada via Idaho route 55, U.S. 95, and I-80.

*Silver Eagle* ran all their field test trips from their distribution center in northeast Portland via route I-84 to Boise, Idaho.

### **Drivers**

One hundred ninety-one drivers took part in the field study. However, many of these individuals took only one or two trips under the program. A core group of forty-one drivers, however, took 74 percent of the field study trips. These drivers had an average age of forty-four years, ranging from thirty-one to sixty-five. They also had an average of twenty-one years of experience driving heavy trucks, ranging from ten to thirty-eight years. A listing of all drivers participating in the study, indicating the number of test trips each took, is contained in appendix G.

The plan for this field test was to use dedicated drivers on dedicated routes. The concern was primarily with training, particularly in the use of C-dollies and in the special skills required for handling electronic data. Only partial success was achieved in this regard, however.

ShopKo and Silver Eagle were able to adjust their operations to substantially meet our goal. ShopKo was uniformly successful in this, and Silver Eagle used substitute drivers on only 8 percent of their trips.

Albertsons had the least controlled routes and used the most drivers. They used eighty-five drivers, resulting in an average of only 2.4 trips per driver. Only 10 percent of Albertsons' drivers ran ten or more trips.

Fred Meyer and PayLess also used a large number of drivers, but both relied heavily on experienced drivers. Fred Meyer used fifty-two drivers for 273 trips, an average of over 5.3 trips per driver. However, nine drivers ran 76 percent of all Fred Meyer trips. PayLess used twenty-seven drivers for 428 trips, an average of 15.9 trips per driver, but eight drivers ran 91 percent of all PayLess trips.

### **Electronic Data Systems**

The test vehicles were instrumented in order to monitor vehicle performance as influenced by the ABS and C-dollies. Instrumentation was developed by Vehicle Monitor Corporation, based on specifications developed jointly by VMC and UMTRI. (See appendix B.)

Two basic requirements for the design of the electronic data system were that it must (1) minimize the perturbation it caused in fleet operations and (2) be of maximum, long term durability. Given the constant interchange of trailers that takes place in fleet operations, this meant, first and foremost, that each unit's instrument package had to be self contained.

The system developed specifically for this application was comprised of an autonomous instrument and data logging package for each vehicle unit and a hand-held computer which used removable memory cards (about the size of a credit card) for downloading data from the on-board data logger. In this system, data were downloaded by the driver or mechanic upon the making or breaking of the vehicle (adding or removing trailers). Later, the data cards were turned in to designated fleet personnel who inserted them into an office computer. Each night, this computer would automatically forward the data by phone to computers at the offices of VMC. After reviewing the data files, VMC would forward them to UMTRI, also by phone line. Time and ID stamps included in the data, along with the driver trip forms filled for each trip, allowed matching data records of individual units during post processing.

Transducers and wiring harnesses for these systems were installed during the initial retrofitting process. The on-board data loggers and hand-held devices, and the software for all elements of the system required more time for development and fabrication such that the system was not fully installed and operational until some nine months after the start of fleet operations.

The systems on the vehicle units transduced the following variables:

- longitudinal acceleration (tractors only)
- lateral acceleration (mid wheelbase, tractors and trailers only)
- wheel rotational speeds (each wheel)
- ABS supply voltage (brake-light circuit voltage) and warning light
- ABS modulator current
- service-brake air pressure
- brake actuation air pressures (each ABS modulator)
- steering activity (C-dollies only, binary signal)

The data records included summary data of the normal performance of the vehicle unit during the trip. These summaries were in the form of histograms revealing the distribution of severity of performance measures, or in the form of event counts. The other form of data record was continuously recorded signals, triggered by the occurrence of significant ABS activity or other indications of unusually severe events. This recording procedure was modeled after the general philosophy of the aircraft crash recorder, although recordings were made of many less-than-catastrophic events.

## **DURATION OF THE STUDY AND MILEAGE ACCUMULATIONS**

The progress of the operational field test in time is illustrated in figure 5.<sup>7</sup> As shown in the figure, fleet operations began as early as August 1993, and extended through most of

---

<sup>7</sup> The planning study for the LCV field test began in September of 1992. That planning study identified all of the partners in the field test—the participating fleets, hardware suppliers and service



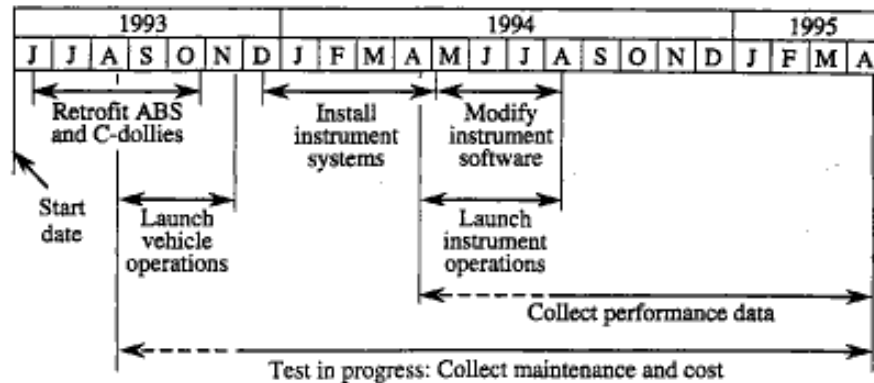

Figure 5. Progress of the operational field test

April 1995. Duration for the individual fleets, as determined by first and last test trip, are given in table 3.

Note from figure 5 that, although fleet operations began in August of 1993, the use of instrumentation systems did not begin until April of 1994. Thus, while the vehicles were monitored for economic performance (reliability, maintenance activity and costs, tire wear, etc.) over the full duration of fleet operations, physical performance data were not gathered over roughly the first half of the test period.

During the time of the study, the individual units accumulated a total of 10.5 million unit-miles. This mileage accumulation is reviewed in figure 6. The figure shows that, of these 10.5 million miles, 6.1 million miles were accumulated in field-study trips, and 4.4

Table 3. Duration of the LCV field test

Fleet	First trip	Last trip	Duration, weeks
Albertsons	Nov. 21, 1993	Mar. 20, 1995 <sup>†</sup>	69
Fred Meyer	Nov. 4, 1993	Apr. 21, 1995	76
PayLess	Oct. 15, 1993	Apr. 22, 1995	79
ShopKo	Aug. 23, 1993	Apr. 6, 1995 <sup>††</sup>	84
Silver Eagle	Oct. 3, 1993	Mar. 31, 1995	77

<sup>†</sup> The last regular test trip was run on February 11, 1995. Three special trips were run subsequent to this date with added instrumentation.

<sup>††</sup> The last trip on the Coeur d'Alene/Post Falls/Spokane route occurred on Jan. 4, 1995.

organizations; it laid out the details of the very substantial startup activity in which ABS, C-dollies, hitches, wiring, and instrumentation would be purchased and fitted to the test vehicles; and it established procedures and mechanisms for gathering all the necessary data for analysis of economic (maintenance, reliability, etc.) and physical performance (stability, etc.) of the fleet. The plan was submitted in March of 1993 and approval to proceed with the main study became effective on June 1, 1993.



million miles were accumulated outside of the study.<sup>8</sup> Outside miles were accumulated mostly by tractors; the business realities of the participating fleets required that their expensive power units be utilized to a greater extent than would have been possible if they were restricted to study operations only. Based on all miles, the units in the study averaged 221,247 miles per tractor, 57,344 miles per trailer and 64,839 miles per C-dolly.<sup>9</sup> *The analyses of maintenance expenses which follow in later chapters are typically based on these total mileage accumulations, not just on the miles accumulated in field-study trips.*

Figure 6 indicates that 1.4 million travel miles were covered in field study trips. (By definition, there is a virtual one-to-one comparison between field-study-trip miles and the miles accumulated by tractors on field-study trips.) Figure 7 reveals that approximately half (52 percent) of these miles were accumulated by Rocky Mountain doubles. Twenty-nine percent of field-study-trip miles were accumulated by triples and 19 percent by western doubles.

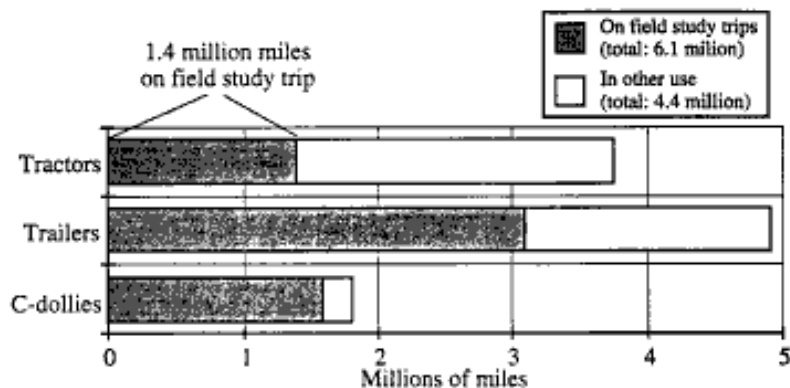

Figure 6. Unit-miles accumulated during the LCV field study

The lower bar in this same figure indicates both the accumulation of trip-miles by A-trains and C-trains and the trip-mileage in which full instrument data were recovered, as opposed to partial or no data. Dealing first with the subject of instrument data, it has already been noted that approximately one-half of the test was conducted prior to the implementation of the electronic data systems. During the rest of the test, *full* electronic data records were obtained for about 45 percent of trips. A successful trip, in this respect, required that only instrument-equipped units were present in the vehicle, that all elements of

<sup>8</sup> The simplest definition of a field-study trip is a trip for which the driver submitted a trip report. Practically, a field-study trip was a trip with a field-study tractor pulling field-study dollies and trailers. Occasionally, particularly early in the program, these trips were not *pure* in that a vehicle included one or more nonstudy units.

<sup>9</sup> The latter two figures, in particular, are too small to represent full maintenance cycles. In the cost analyses presented in later chapters, we have made some attempts to compensate for this based on historical maintenance records derived from the files of the participating fleets.

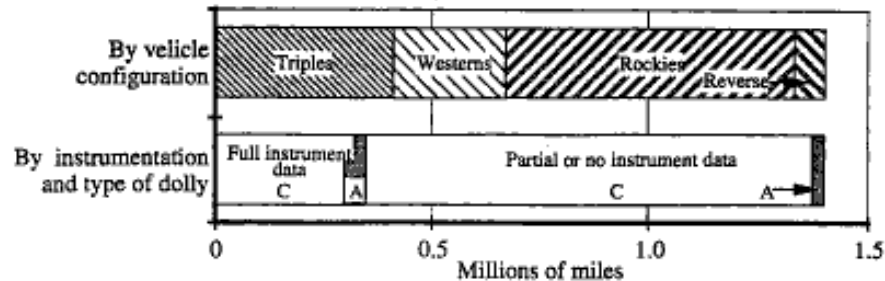

Figure 7. Distributions of trip miles accumulated in the LCV field study

the individual instrumentation and data logging systems on each unit of the vehicle functioned correctly, that the fleet personnel performed both the trip logging and data downloading and transmission tasks properly for each unit, and that the electronic data transmission system from fleet office to VMC to UMTRI worked properly in terms of both hardware and software. Less-than-perfect reliability of each of these elements combined to cause an overall success rate for electronic data collection of roughly 45 percent. (The authors look upon this with mixed feelings: Forty-five percent success does not seem so good. However, even at this rate, the amount of data collected was somewhat overwhelming.) *The analyses of ABS and C-dolly performance which follow in later chapters are generally based on these 350,000 trip miles.*

Figure 7 also shows that the large majority of trip miles (94 percent) were accumulated using C-dollies. However, to obtain comparison data in the regime of *physical* performance, it was necessary to operate the *instrumented* fleet with A-dollies for some period of time. Considering the physical performance problem only, a fifty-fifty split would probably have been most desirable. However, given (1) the limited time period (and mileage) of the study, (2) the strong interest in operational data, and (3) a presumption, based on previous research, that the contrast between A-train and C-train behavior would be readily apparent, an effort was made to maximize the miles accumulated with C-dollies. Thus, only 16 percent of these 350,000 miles were gathered using A-dollies. The remaining 84 percent were with C-dollies.

Finally, it should be noted that the 1.4 million miles of trips monitored in this study is *much* too small a base for arriving at any statistical conclusions regarding accident rates. It happens that one serious accident did occur during this study.<sup>10</sup> About all that can be said is that this accident rate (one in 1.4 million miles) is quite compatible with the accident rates of trucks as reported in the literature.[12,13]<sup>11</sup>

<sup>10</sup> The accident involved injury to occupants of the other vehicle and tow-away of that vehicle.

<sup>11</sup> For example, the combined rates for injury and tow-away accidents reported in FHWA's *Truck and Bus Accident Factbook 1992* is 0.69 accidents per million miles.[12]

## ESTUDIO DE INVESTIGACIÓN DE LA UNIVERSIDAD DE MICHIGAN

Puede ser consultado en:

<http://www.hti.umich.edu/cgi/t/text/text-idx?sid=50cf84488b83cc2b8ba0554be1cc5c98;c=umtri;idno=88519.0001.001>

The accident took place while the installation of the electronic data systems was still in progress and before regular downloading of data had commenced. Nonetheless, it was possible to retrieve data records from two of the four units involved in the accident. (The vehicle was a Rocky Mountain double.) Although this event is anecdotal in the context of this study, a rather detailed analysis of the available data is presented in appendix N.

## **THE PERFORMANCE OF ANTILOCK BRAKING SYSTEMS ON LONG COMBINATION VEHICLES**

The experience of this field study has led to a number of significant observations regarding the performance of antilock braking systems on LCVs. Principal among these are: (1) ABS can be expected to play a significant stability-enhancing role in some ten to twenty severe braking events per 100,000 miles of LCV travel (i.e., a period of more or less one year for a professional LCV driver). (2) ABS activity was seen to take place about as frequently on dollies as on trailers, suggesting that, for stability in braking, ABS are as important on A-dollies as they are on trailers. (3) Under specific conditions, sufficient electrical power for the operation of ABS on trailers and dollies was reliably provided via the brake-light circuit. The conditions were (a) the special modifications to the wiring of all the tractors and trailers in the study, (b) the tractor electrical system providing a minimum of 13.3 volts, and (c) the ABS on dollies and trailers needing no more than 9.0 volts for proper operation.

This chapter presents the analyses related to these and other observations on ABS activity in the LCV study fleet, brake-light-circuit voltage on LCVs, and a general characterization of the longitudinal behavior of LCVs.

### **ABS ACTIVITY IN THE LCV STUDY FLEET**

In this section, the ABS activity observed in the test fleet of the LCV field study will be characterized in the following ways:

- the severity of ABS braking events throughout the combination as indicated by the number of vehicle units simultaneously experiencing ABS activity
- the severity of ABS braking events within each vehicle unit as indicated by the number of distinguishable slip cycles in the event
- the distribution of ABS braking activity according to unit position in the combination

Characterizations of these types are produced for doubles and for triples, respectively, and in relation to loading condition and to speed of travel.

Before starting the discussion, it will be helpful to define ABS activity, and its various levels, as used herein. The analyses of this section have their basis in the continuous time recordings of vehicle performance data which were taken during so-called *ABS events*. However, not all ABS activity was recorded. A great number of insignificant (i.e., extremely short) modulator control signals are generated by the ECUs of some systems. The size of the memory on the data loggers would not allow continuous recording each time such an insignificant signal was observed. Continuous recording was initiated—and

therefore, a significant *ABS event* was defined to exist—only when the ECU signal to a modulator valve was on for at least 20 percent of a 0.1 second time period. (For more details, see appendix B.)

The data gathered during each recorded event were later analyzed to determine the *severity* of the event based on the number of observable ABS response cycles. Response cycles were identified through analysis of the recordings of both brake chamber air pressure and wheel speeds. Even though the most insignificant ABS activity was not recorded, there were still a substantial number of recorded events in which no significant cyclical response to the control signal was identified. Other events had one or more identifiable response cycles and a few had four or more cycles. Where appropriate, results are presented according to the number of cycles observed in the event.

#### **Characterization Of The Braking Events Of LCVs Based On The Number Of Units Involved In ABS Activity**

This section examines the severity of ABS activity during braking events where severity is judged by the number of units of the combination that experience ABS activity during the event. Although the data loggers on each vehicle unit were autonomous, time stamps in the data record allowed for identifying those ABS events from the several units of the vehicle that occurred in near proximity in time. Thus, braking events could be analyzed throughout the vehicle combination in order to determine the number of vehicle units on which ABS activity took place during the event. In the presentations that follow, ABS braking events are characterized as involving one, two, three, or four units of the vehicle. (Triple-trailer combinations, of course, include six units, but no events involving more than four units were observed in normal operations during this study.)

Figure 8 presents three column graphs, which describe the occurrence of LCV braking events observed in this study according to the number of units displaying ABS activity during the event. Each graph distinguishes between doubles and triples by the shading of the columns.

The first graph at the top of the figure presents the distribution by severity in terms of percentage of all events observed during the study for the configuration (i.e., for doubles and triples separately). The second graph shows the average *rate* at which these events occurred in terms of events per hour of travel, and the third graph shows the *rate* of occurrence in terms of events per 100,000 miles of travel. (One hundred thousand miles was chosen as the value for normalizing because this is roughly equivalent to a driver's experience for one year.)

The following conclusions can be drawn based on the three graphs of figure 8.

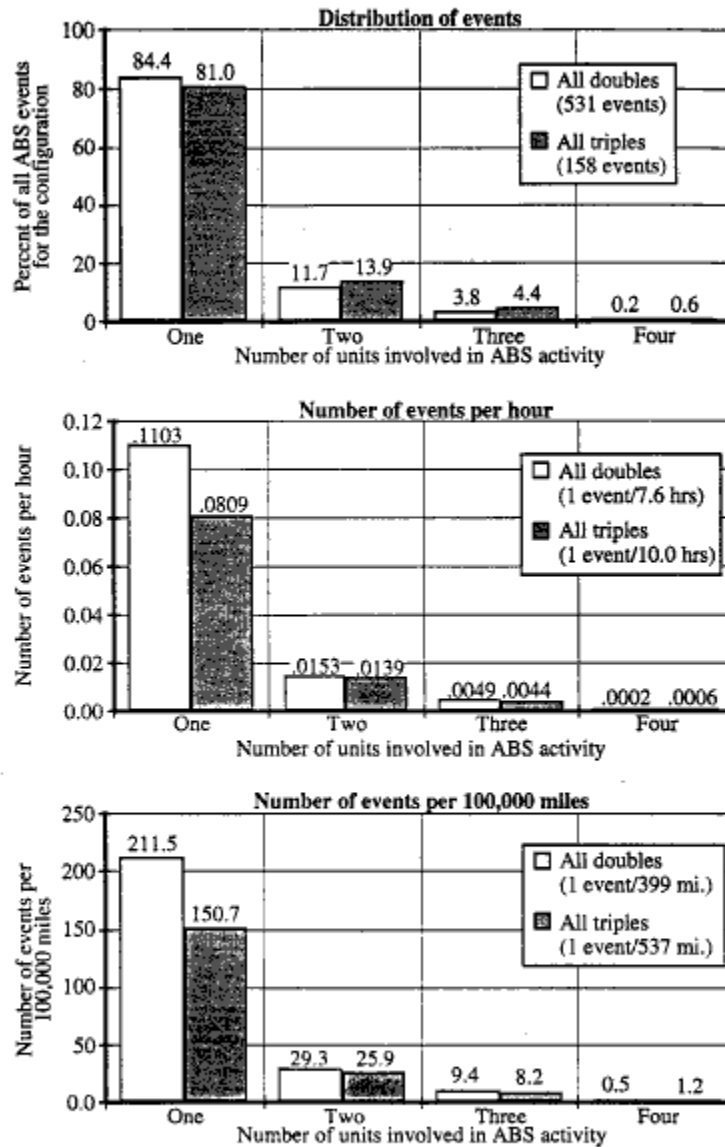

Figure 8. The occurrence of LCV braking events according to the number of units exhibiting ABS activity during the event

- Over 80 percent of all ABS events observed involved only one unit. Twelve to 14 percent involve two units, and 4 or 5 percent of these events were severe enough to involve ABS activity on three or more units of the vehicle.
- An ABS event is experienced, on average, once in every eight to ten hours of travel. Events involving ABS activity on two units occur about once every seventy hours, and events involving three or more units occur, on average, about once every 200 hours of travel.
- On average, a driver can expect to experience 190 to 250 (for triples and doubles, respectively) ABS braking events per 100,000 miles (roughly a year for professional drivers). Of these, twenty-five to thirty can be expected to involve two units and nine or ten to involve three or more units of the vehicle.

Figures 9 and 10 present results examining ABS activity on LCVs in more detail. These figures examine the influence of loading condition and speed of travel, respectively. (The data from which these figures were generated are presented in tabular form in appendix H.)

Figure 9 contains six column graphs, which show the distributions of ABS events for doubles and triples, respectively, according to loading condition (shown on the horizontal axis). The distribution of events according to severity is now shown simultaneously by the shading within each individual column. The various shadings indicate whether one, two, three, or four units exhibited ABS activity during the braking event.

The figure contains three pairs of graphs. The top pair show, in percentages, the distribution of braking events that took place during the study for doubles and triples, respectively. These graphs show that, *in this study*, there were far fewer events for vehicles with mixed loads than for vehicles that were either empty or fully loaded. For doubles, nearly twice the number of events took place with empty vehicles than with loaded vehicles. For triples, the counts for empty and loaded vehicles were nearly the same. These results, however, are, in part, only an artifact of the amount of travel that took place in these loading conditions during this study. These distributions can be generally representative only if the distribution of travel accomplished by the fleets in this study in these various loading conditions is generally representative.

The center and lower pairs of graphs of figure 9 provides greater insight into the distribution of ABS events. These graphs present results which are normalized for the amount of travel. In a manner similar to the presentations of figure 8, the center graphs present *events per hour* of travel and the lower graphs present *events per 1,000 miles* of travel. These four plots show the relative propensity for ABS activity more clearly.

- The *rates* of ABS activity are greatest in vehicles with mixed loading conditions, next largest in vehicles that are empty, and smallest in vehicles that are fully loaded.



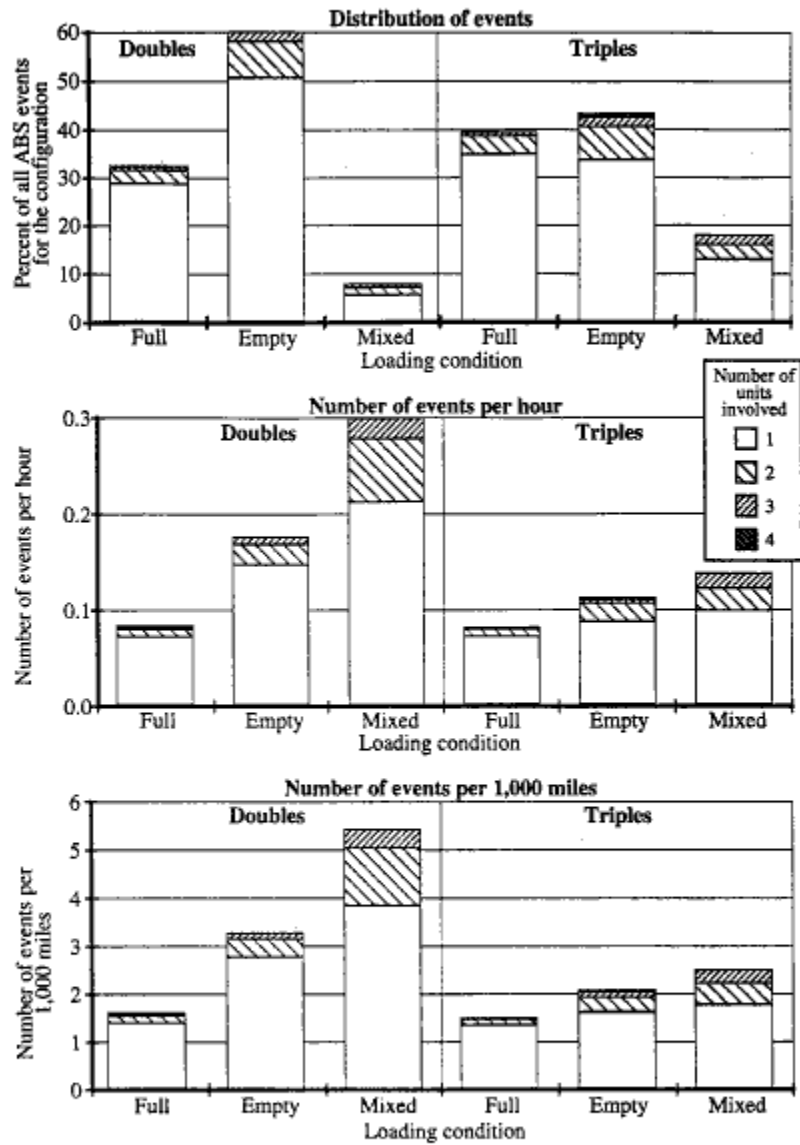

Figure 9. The occurrence of LCV braking events according to loading condition and the number of units experiencing ABS activity

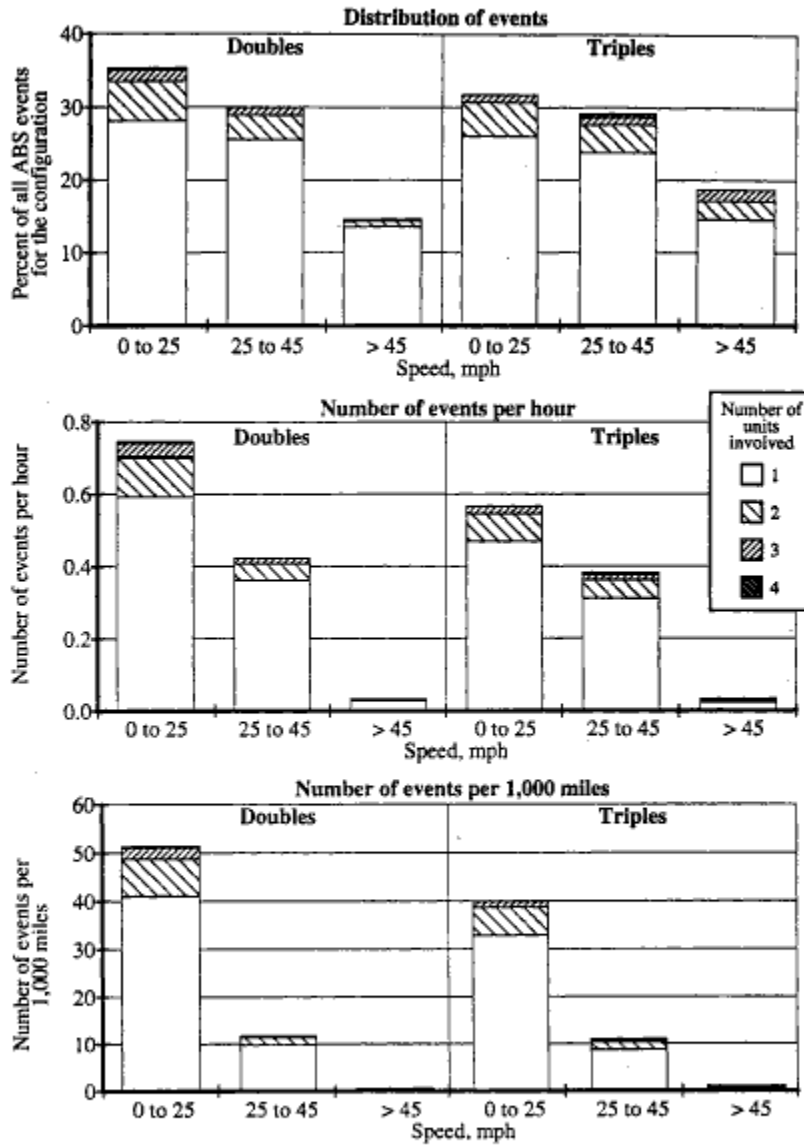

Figure 10. The occurrence of LCV braking events according to speed of travel and the number of units experiencing ABS activity

- Comparing doubles versus triples, the *rates* of ABS events are very similar for loaded vehicles, but the rates for doubles are substantially higher than those for triples when the vehicles are either empty or in a mixed-load condition.

The first point clearly would be expected from an understanding of the physics of the braking process. A mixed loading condition implies an imbalance in the proportioning of braking effort relative to load. The lightly loaded wheels tend to lock when braking power adequate to stop the heavier units is applied. Empty vehicles display a similar, if not as severe, imbalance between the heavy tractor and lighter trailers.

One other element of these data is somewhat surprising. That is, doubles with mixed loading show a relatively high propensity for events involving *three* units. As implied above, events in doubles with mixed loading would be expected to involve one or two units—the lightly loaded trailer and its dolly (or, occasionally, the tractor). The prevalence of events involving three units in triples is not so puzzling, since in this case, *two* of the three trailers may be lightly loaded.

Figure 10 is virtually identical to figure 9 except that the horizontal axis now shows speed of travel rather than loading condition. The six graphs of this figure all the general observations:

- Braking events in LCVs that involve ABS activity tend to occur more often at lower speeds.<sup>12</sup> Less than 20 percent of the (vehicle) ABS events observed occurred at speeds greater than 45 mph. This is so for both doubles and triples.
- When the counts of ABS events are normalized for the amount of travel (hours or miles), this trend is exaggerated. The *rates* of ABS events observed are much higher at lower speeds.

The data also show a modest trend for the more severe events to occur at moderate and lower speeds (i.e., below 45 mph).

Finally, if we combine the information presented in the bottom graph of the first figure in this section (figure 8) with the information in the top graph of the last figure (figure 10), we can add detail to our picture of the experience of the average driver. Averaging the data for doubles and triples, table 4 shows the expected number of ABS events experienced, on average, in 100,000 miles of travel according to severity (number of units involved) and speed of travel.

Positions low and to the right in this table represent the conditions of greater safety significance. If it is assumed that the three cells in the lower right (with numbers in bold

<sup>12</sup> "Speed," here and in the graphs of this section, is the maximum travel speed observed in the recorded data for the event. If the ABS activity took place late in a braking event of relatively long duration, the initial speed of the braking event may have been considerably greater than the speed identified for the *ABS event*.

**Table 4. Expected distribution of ABS events experienced by a driver of LCVs over 100,000 miles (218 events)**

<i>Travel speed, mph</i>	<i>Severity, number of units experiencing ABS activity</i>		
	<i>One</i>	<i>Two</i>	<i>Three or more</i>
<i>0 to 25</i>	75	14	4
<i>25 to 45</i>	68	10	4
<i>over 45</i>	38	4	2

type) represent events in which, without ABS, instability due to wheel lock is probable, then it follows that ABS on trailers and dollies would enhance stability and are a potential safety aid in approximately ten events per year per driver (i.e., per 100,000 miles of travel). Inclusion of the fourth cell in the lower right area (i.e., the cell for two units and 25 to 45 mph) would raise this estimate to twenty events per year.

#### **Characterization Of Braking Events Of Individual Units Based On ABS Activity Within The Unit**

This section examines the severity of ABS braking events experienced by the LCV field study fleet on an *intraunit* basis. As described in the introductory portion of this section, the continuous data recordings from each individual ABS event were analyzed to determine the number of observable ABS response cycles that took place during the event. Cycles were identified by examining the recordings of both brake chamber air pressure and wheel speed. (See appendix B for details.)

Figures 11 through 13 present the results of these analyses. (The data of these figures are presented in tabular form in appendix H.) These figures are of identical form to figures 8 through 10, which were presented in the previous subsection. In these figures, however, the shading of the columns is used to represent the number of ABS response cycles observed.

The first graph at the top of figure 11 reveals the primary additional finding of this subsection, namely that:

- Approximately 70 percent of the (intraunit) ABS events observed did not show substantial cycling response of brake chamber air pressure and wheel speeds. This is in spite of the fact that the threshold of activity required to initiate recording would, itself, filter out a great deal of insignificant activity. From one quarter to one third of the events observed do involve cyclic response. Events with two or three cycles made up about 7 percent of the observations and events with four or more cycles were about 3 percent of the observations.

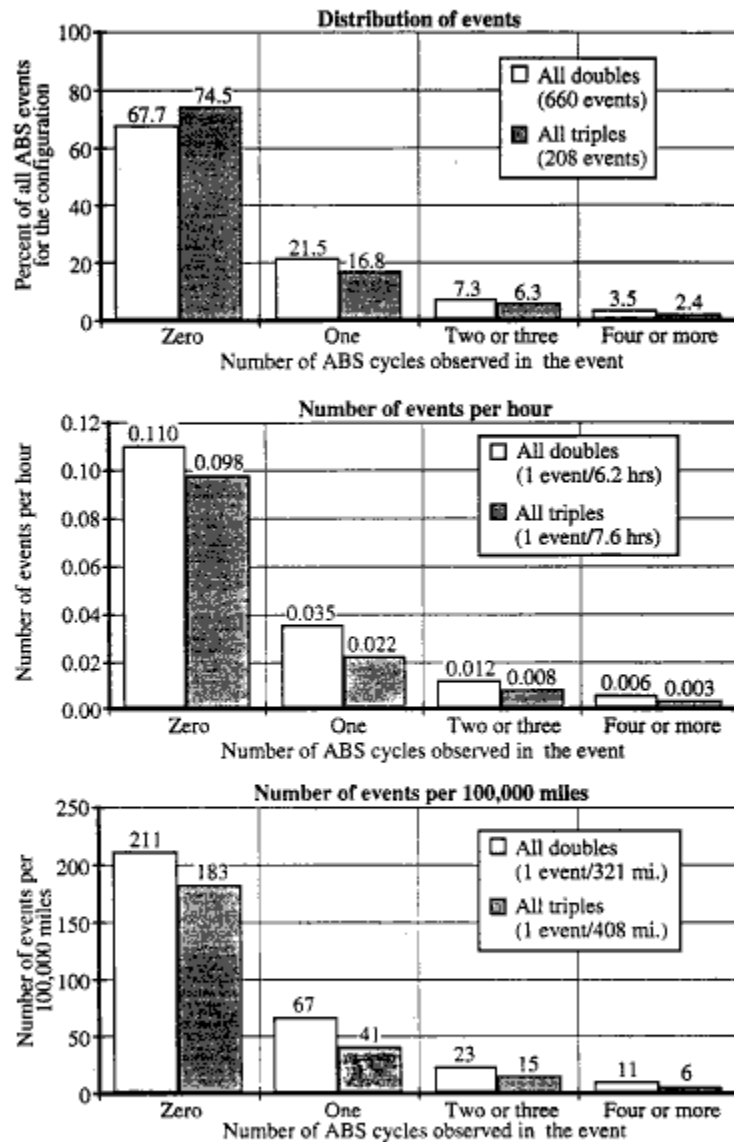

Figure 11. The occurrence of intraunit braking events according to the number of ABS cycles observed during the event

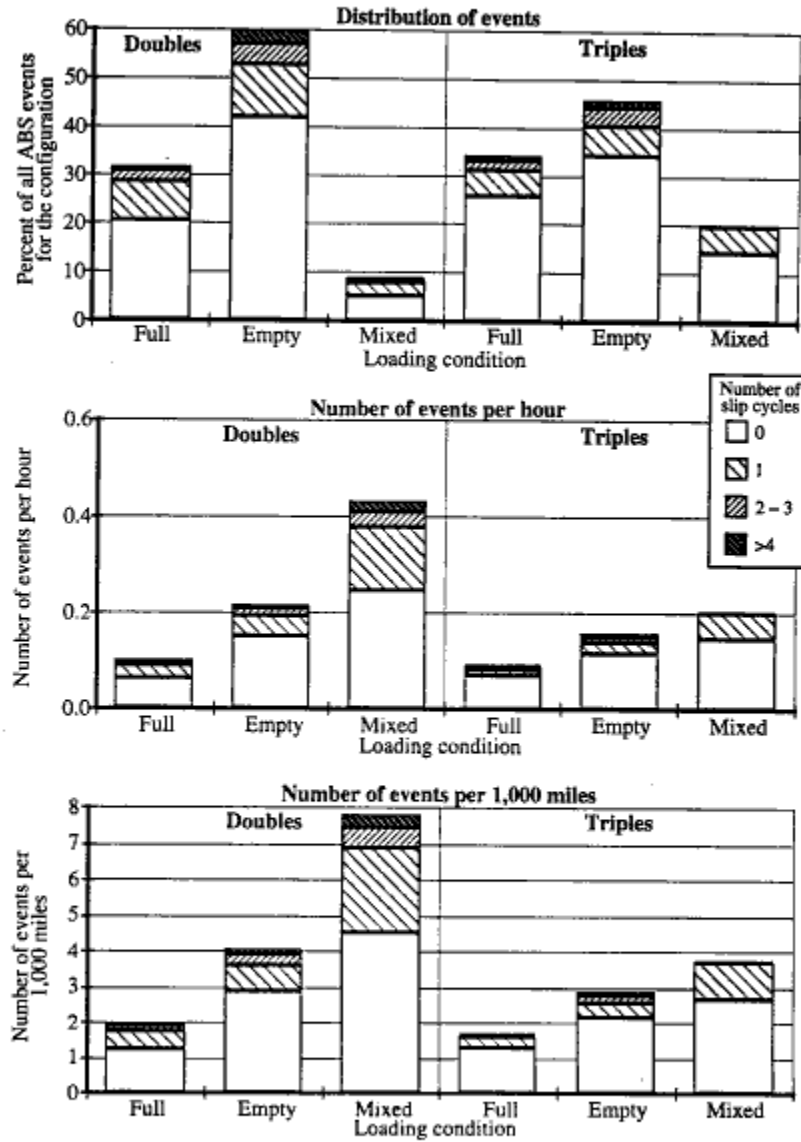

Figure 12. The occurrence of intraunit ABS braking events according to loading condition and the number of ABS cycles during the event

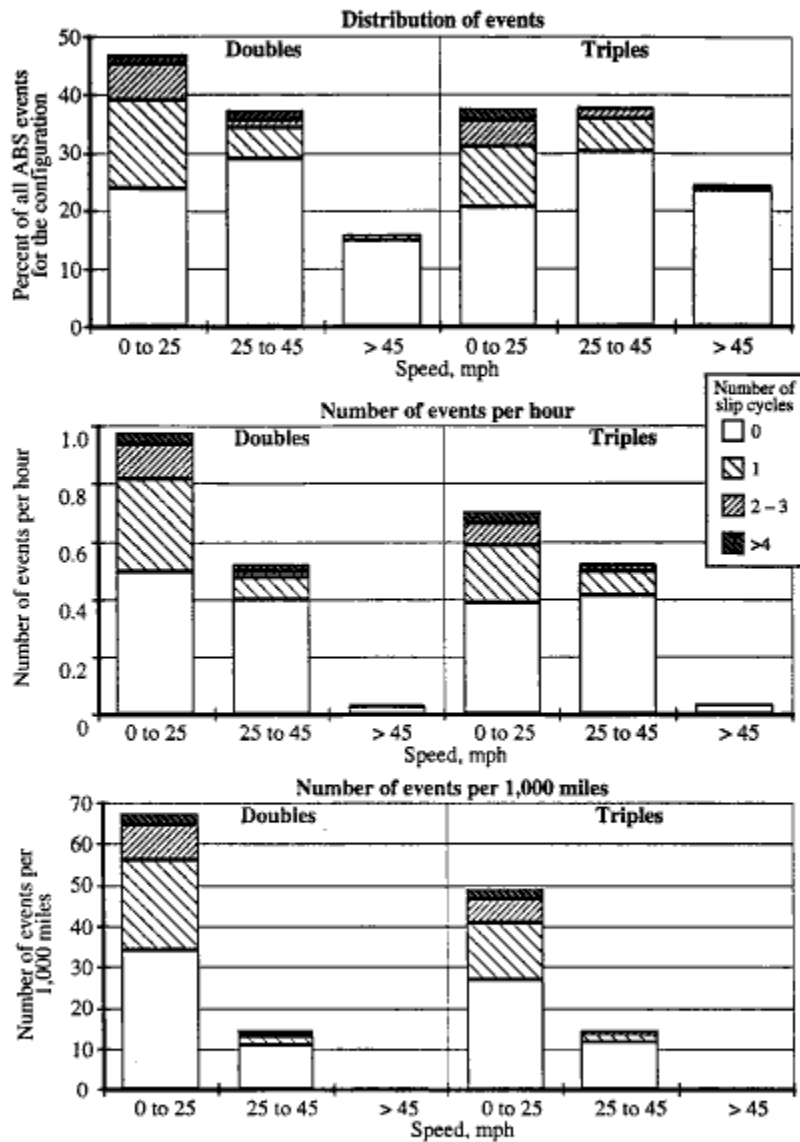

Figure 13. The occurrence of intraunit ABS braking events according to speed of travel and the number of ABS cycles during the event



The lower two graphs of the figure indicate the rates at which ABS events were observed according to time of travel and miles of travel. The data in these graphs can be analyzed to reveal that:

- An ABS event involving at least one cyclical response occurs, on average, about once every twenty to thirty hours, or every 1000 to 1600 miles, of travel. (Both sets of figures are for doubles and triples, respectively.) One third of *these* events involve more than one cycle and about 10 percent involve four or more cycles.

All of the graphs presented in figures 11 through 13 are markedly similar in form to their counterparts in figures 8 through 10. In retrospect, it is not at all surprising that the two measures of severity of events—number of vehicle units involved and number of ABS cycles observed—would correlate quite well. Thus, in general, the qualitative observations made in the preceding section apply very well to the data of this section also.

#### **The Distribution Of ABS Braking Activity According To Unit Position In The Combination**

Figure 14 presents the distribution of (intraunit) ABS events observed in this study according to vehicle unit. The upper graph of the figure shows this distribution for triples. The observations for all doubles combined are shown in the lower graph. Each graph distinguishes between vehicles which are fully loaded, empty, or partially loaded. The height of the columns indicates percentages of events experienced by the type of unit (summing to 100 percent for each combination of configuration and loading condition). (The data represented in these graphs are presented in tabular form in appendix H. The presentation in the appendix distinguishes among specific configurations of doubles.)

This figure only appears to suggest one strong trend: Some 70 to 80 percent of ABS activity in LCVs with mixed loading occurs in the combination of the last trailer and its dolly. Beyond this, no other strong trend is readily apparent. In triples, there does appear to be a tendency for activity to take place in the tractor and dollies more often than in the trailers, but this trend is not continued in doubles. (Nor is it evident in the data for western doubles taken alone. See appendix H.)

This relatively even distribution of ABS events throughout the combination vehicle suggests that, for stability enhancement, ABS is at least as important for A-dollies as for trailers. Given the A-dolly's greater propensity for unstable yaw response relative to trailers,<sup>13</sup> one could argue, in the face of these data, that ABS is more important for A-dollies than for trailers. On the other hand, the double-tow-bar configuration of C-dollies eliminates any possibility of jackknife of the dolly, reducing the safety significance of ABS on this type of unit (assuming that the trailer towing the dolly is equipped with ABS).

<sup>13</sup> The shorter wheelbase and light weight of dollies promotes quicker and larger jackknife of dollies than of trailers.

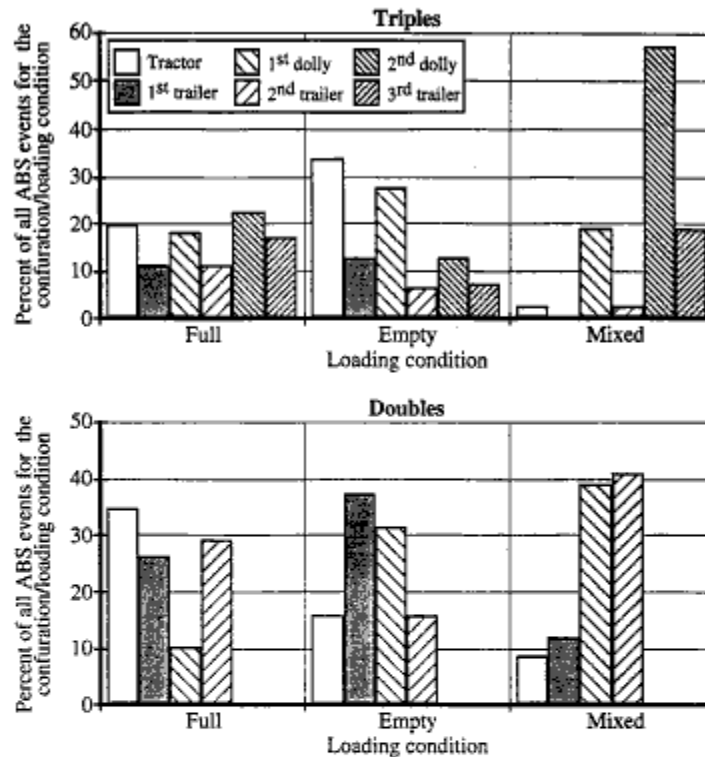

Figure 14. Distribution of ABS events among the units of LCVs as a function of loading condition

### POWERING ABS ON LCVs THROUGH THE BRAKE-LIGHT CIRCUIT

An important objective of the program was to determine conditions under which sufficient electrical power for the operation of ABS on LCVs could be provided through the brake light circuit using the conventional seven-pin connector.<sup>14</sup> To this end, special wiring modifications were made to both the tractors and the trailers used in the study in order to provide an electrical system optimized for this purpose. Then, data on the brake-light-circuit voltage were measured and collected for all units operating in the field study.

<sup>14</sup> The reader should keep in mind that in this field study, all trailer and dolly ABS were powered through the brake-light circuit. That is, throughout this discussion, ABS supply voltage and brake-light-circuit voltage should be recognized as virtually one and the same.

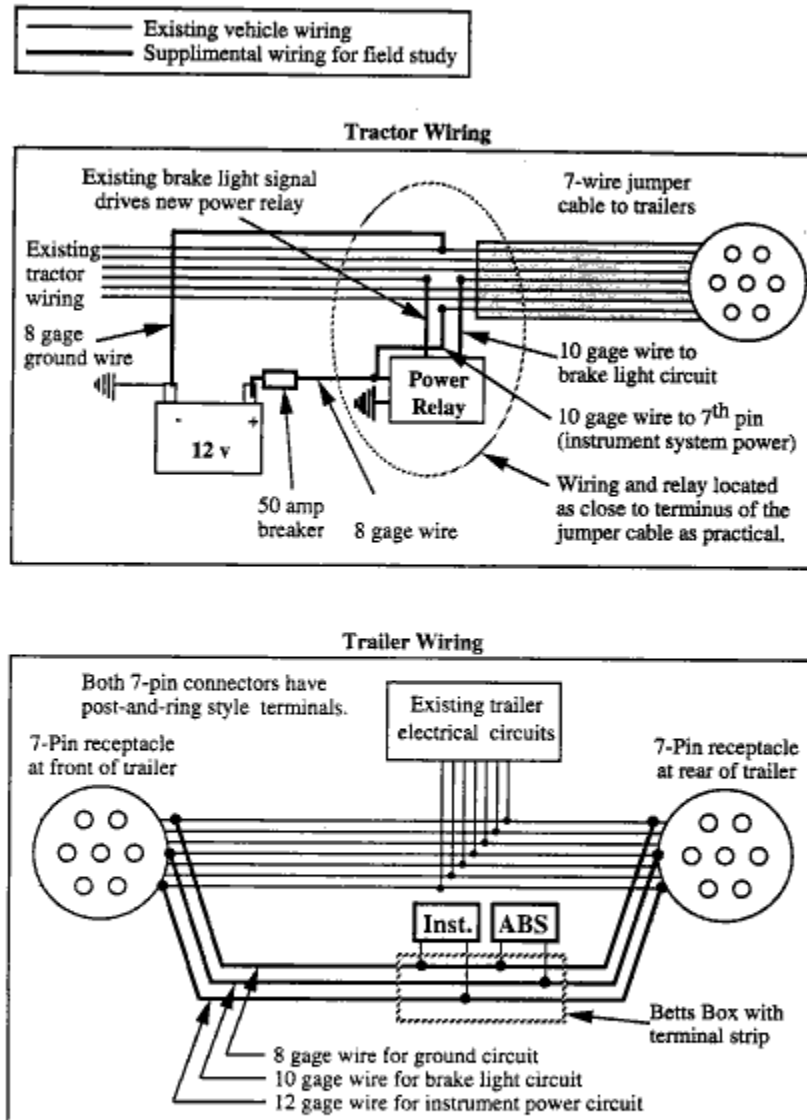

Figure 15. Supplemental wiring for the tractors and trailers in the LCV field study

The alterations to the electrical systems of the vehicles of the study are shown schematically in figure 15. All tractors were equipped with heavy gage wiring for the ground and brake-light circuits feeding the seven-wire jumper cable to the trailers. Further, brake-light circuits were modified such that brake-light power was provided to the trailers through a high-capacity power relay, rather than directly through the brake-light switch. On the trailers, the existing wiring was supplemented with heavy gage wiring for ground and brake-light circuits. The new wiring ran from the front to the rear junction box of the trailers, and power was provided to the ABS via this wiring. The existing trailer circuits were left in tact. All trailers were equipped with new seven-pin connector sockets front and rear, and all of the seven-wire jumper cables used in the study were of the heavy duty type. [5,6,7,8]

It must be pointed out at the outset of this discussion, that the results that follow are partially dependent on the relatively brief duration of the field study test (1.5 years). Given that all the units were outfitted with new connectors and wires, the results do not include the detrimental effects of corrosion and other degradations that occur with extended age.

The following discussion presents brake-light-circuit voltages as measured for two distinct conditions: (1) during normal brake applications (i.e., brake applications in which ABS was not active), and (2) during periods of significant activity of the ABS modulator valve.

#### **Brake-Light-Circuit Voltage In Normal Braking**

Results for brake-light-circuit voltages during normal braking are given in figure 16 and in table 5. These results derive from literally thousands of measurements of brake light voltage. The instrumentation system on each unit continuously observed the brake light circuit voltage. Each time this voltage changed from an OFF condition (near zero) to an ON condition, the ON voltage was recorded along with the time of the measurement. The results presented in the figure and table derive from these recorded voltages.

The figure shows the average brake-light voltage observed on each unit of doubles and triples, respectively. Results are shown separately for vehicle combinations using incandescent and LED (light-emitting diode) brake lights. These average voltages plus standard deviations about the averages, and the voltage drops between adjacent units are presented in table 5.

The relationships between the individual datum of figure 16 are generally as would be predicted by simple electrical circuit theory. That is:

- The average brake-light-circuit voltages decline from the front to the rear of the vehicle.
- For each respective vehicle/lamp configuration, the largest voltage drop occurs between tractor and first trailer. For vehicles with incandescent lamps, this drop

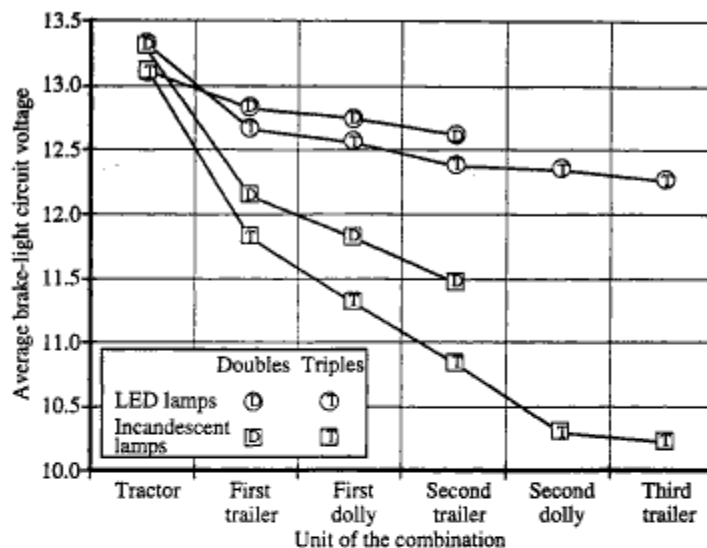

**Figure 16. Average brake-light-circuit voltage during normal braking**

exceeds a full volt. These interunit voltage drops typically become smaller toward the rear of the vehicle.<sup>15</sup>

- Brake-light-circuit voltages fall off more severely in triples than in doubles in the progression from front to rear.
- Brake-light-circuit voltages are substantially higher when LED lamps are used rather than incandescent lamps, due to the lower current draw of LED lamps.

The data of the figure and table reveal other results with significant implications, namely:

- The tractors provide a voltage *source* for the brake-light circuit which averages in the range of 13.1 to 13.3 volts.<sup>16</sup> This varies appreciably within the fleet, however, as indicated by standard deviations of nominally 0.2 volts.
- Even in normal braking (without the electrical loads of ABS activity), brake-lamp-circuit voltages dropped to 10.2 volts *on average* in the third trailer of triples using

<sup>15</sup> In theory, the data should show this to be strictly true. The overall trend is evident from the general curvature of the four plotted lines of figure 16. Variations from this principle are probably the results of variations in instrument calibrations across the 131 units and one year of use.

<sup>16</sup> Measurement of the brake-light-circuit voltage on tractors was made at a point in the circuit before the power relay and jumper cable.

**Table 5. Statistics of the brake-light-circuit voltages measured in normal braking**

	<i>Tractor</i>	<i>First trailer</i>	<i>First dolly</i>	<i>Second trailer</i>	<i>Second dolly</i>	<i>Third trailer</i>
<b>Doubles with incandescent lamps</b>						
<i>Average, volts</i>	13.27	12.15	11.81	11.46		
<i>Standard deviation, volts</i>	0.17	0.18	0.22	0.24		
<i>Inter-unit drop, volts</i>		1.12	0.34	0.35		
<b>Triples with incandescent lamps</b>						
<i>Average, volts</i>	13.13	11.81	11.31	10.83	10.29	10.23
<i>Standard deviation, volts</i>	0.16	0.23	0.25	0.29	0.24	0.31
<i>Inter-unit drop, volts</i>		1.32	0.50	0.48	0.54	0.06
<b>Doubles with LED lamps</b>						
<i>Average, volts</i>	13.11	12.82	12.75	12.62		
<i>Standard deviation, volts</i>	0.22	0.24	0.26	0.27		
<i>Inter-unit drop, volts</i>		0.34	0.05	0.14		
<b>Triples with LED lamps</b>						
<i>Average, volts</i>	13.31	12.67	12.57	12.37	12.35	12.26
<i>Standard deviation, volts</i>	0.20	0.30	0.25	0.25	0.51	0.25
<i>Inter-unit drop, volts</i>		0.65	0.08	0.23	0.01	0.09

conventional incandescent bulbs. A standard deviation of 0.3 volts for this measure suggests many incidents wherein this voltage was well below ten volts.

#### **Brake-Light-Circuit Voltage During Braking With ABS Activity**

The instrumentation system on each vehicle unit recorded brake-light-circuit voltage continually during braking whenever there was significant ABS activity on that unit. These continuous recordings of brake-light-circuit voltage were analyzed to determine the percentage of time that this voltage (which is the ABS supply voltage) fell below three specific voltage thresholds.<sup>17</sup> The voltage thresholds were those reported by the ABS manufacturers as the recommended minimum operating voltages of the three brands of ABS used on the dollies and trailers of the field study.

The results that follow represent voltages observed under a broad, and presumably representative, mix of conditions of ABS activity. The instrumentation systems on each

<sup>17</sup> Details of the analysis method appear in appendix B.

vehicle unit were autonomous and did *not* communicate with other units of the combination. Thus, brake-light-circuit voltage on a given unit was recorded when the ABS on that unit was active, regardless of the state of ABS activity on other units. The results presented here do not distinguish between different conditions of ABS activity elsewhere in the vehicle. Also, some of the trailers of the test fleet were equipped with ABS using two modulator valves and some with systems using only one valve. The results presented here are for all ABS activity, be it activity of one valve alone or two valves simultaneously. Results from similar analyses carried out for single-valve activity only appear in appendix H.

The results for double- and triple-trailer combinations with *incandescent brake lamps* are shown in table 6 and figure 17. The figure shows the percentage of the total time of ABS activity during which the brake-light-circuit voltage fell below the indicated threshold voltages. This is done separately for doubles and triples and for each unit position of the combinations. The table presents similar results in seconds rather than percentage, and also presents the total ABS event time.

Analysis of the data for vehicles equipped with *LED brake lamps* showed that the brake-light-circuit voltage remained above all three threshold voltages during virtually all ABS activity. This was true for both double-trailer and triple-trailer vehicles.

**Table 6. ABS event times for doubles and triples using incandescent brake lamps**

	<i>Tractor</i>	<i>First trailer</i>	<i>First dolly</i>	<i>Second trailer</i>	<i>Second dolly</i>	<i>Third trailer</i>
<b>All doubles with incandescent brake lamps</b>						
<i>Time below 9.7 volts, sec.</i>	0.0	0.1	10.8	8.4		
<i>Time below 9.0 volts, sec.</i>	0.0	0.0	4.5	5.3		
<i>Time below 8.5 volts, sec.</i>	0.0	0.0	2.0	1.8		
<i>Total ABS event time, sec.</i>	29.7	154.5	150.9	108.8		
<b>All triples with incandescent brake lamps</b>						
<i>Time below 9.7 volts, sec.</i>	0.0	0.3	0.0	0.7	9.7	12.3
<i>Time below 9.0 volts, sec.</i>	0.0	0.0	0.0	0.0	4.9	4.3
<i>Time below 8.5 volts, sec.</i>	0.0	0.0	0.0	0.0	2.9	1.0
<i>Total ABS event time, sec.</i>	6.7	21.1	39.7	36.4	56.6	29.6



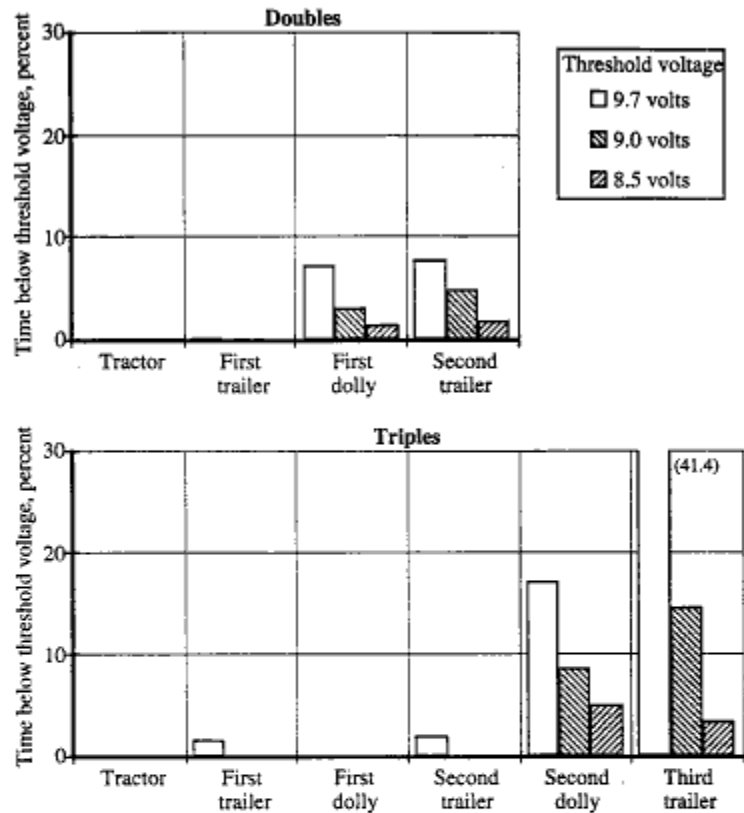

Figure 17. Percentage of time during ABS braking events when the brake-light-circuit voltage was less than the indicated threshold voltage for all LCVs with incandescent brake lamps

#### The Influence Of Tractor Voltage On ABS Supply Voltage On Dollies And Trailers

The voltages available for ABS operation on the rear units of the LCV are a function of (1) the initial supply voltage provided by the tractor electrical system, and (2) the losses that occur due to resistance in the wiring and connectors of all the units of the vehicle. Special efforts were made at the outset of this project to optimize the units of the field study vis-a-vis the second item, but no effort was made to control the first. Clearly, however, the supply voltage provided by the tractor can be expected to have a major influence on the

voltage available for ABS on the dollies and trailers. To examine this influence, ABS voltage data were segregated according to tractor supply voltage, and additional analyses similar to those described above were conducted on each subset of the data. As would be expected, the measures of time-below-voltage-threshold were found to be strongly influenced by tractor supply voltage.

As noted previously, brake-light-circuit voltage was measured and recorded for each individual brake application. (This is virtually always a measure of voltage in the absence of ABS activity, since it is taken very shortly after the brake light switch is activated before ABS activity is likely to start.) These individual measurements were used to calculate the average brake-light-voltage for the tractor in each individual trip. This average value was then used to characterize the tractor supply voltage for all of the units of the vehicle for *that* trip. The brake-light-voltage data from *ABS events* was then subdivided into sets taken from trips in which tractor supply voltage was either more than or less than a specified level, respectively. The two data sets were analyzed to determine their respective measures of time-below-threshold-voltage (that is, *ABS threshold*).

By repeated trials, it was determined that 13.3 volts was a critical value for tractor supply voltage. This held true for both double- and triple-trailer vehicles.

Results for analyses of data subdivided by this supply-voltage criterion are presented in figure 18 and 19 and in tables 7 and 8. The first figure and table show results from trips for which the average tractor supply voltage exceeded 13.3 volts. (This group includes 31 percent of all ABS events for doubles and 40 percent of all ABS events for triples.) The second figure and table is for those trips in which the average tractor supply voltage was equal to or less than this value. The top section of each presents results for all doubles and results for triples are in the bottom section of each presentation.

Figure 18 shows that the voltage supplied to the ABS on all trailers and dollies of doubles was always above 9.7 volts in trips in which the average tractor supply voltage exceeded 13.3 volts. For triples, ABS supply voltage does fall below 9.7 volts for a significant percentage of the time, especially on the third trailer, but these voltages remain above 9.0 volts at virtually all times.

Conversely, figure 19 shows that, for trips in which the average tractor supply voltage was below 13.3 volts, ABS supply voltage falls below the recommended minimums during a substantial percentage of the ABS event time periods.

These results show:

- The brake-light-circuit voltage on the last trailer and the last dolly of both doubles and triples falls below the recommended minimum voltages for ABS operation

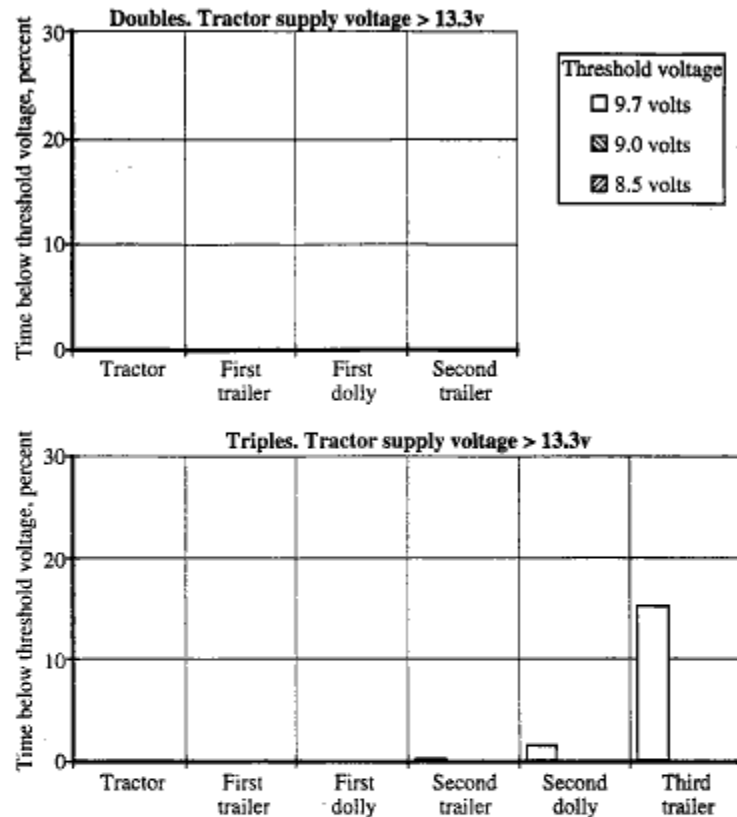

Figure 18. Percentage of time during ABS braking events when the brake-light-circuit voltage was less than the indicated threshold voltage for LCVs with incandescent brake lamps and supply voltages greater than 13.3 volts

during a substantial percentage of the time during ABS activity. This is especially true for triples.<sup>18</sup>

- The time-below-threshold measure is very strongly influenced by the range of threshold voltages examined, that is, 9.7 to 8.5 volts.

<sup>18</sup> The reader may note, and wonder about, the difference between the measures for second trailers of doubles and second trailers of triples, and the similar difference between the measure for first dollies of these two configuration. All other things being equal, one would expect the below-threshold-time to be greater on the units of triples than on the units of doubles. We have no adequate explanation for this apparent anomaly.

Puede ser consultado en:

<http://www.hti.umich.edu/cgi/t/text/text-idx?sid=50cf84488b83cc2b8ba0554be1cc5c98;c=umtri;idno=88519.0001.001>

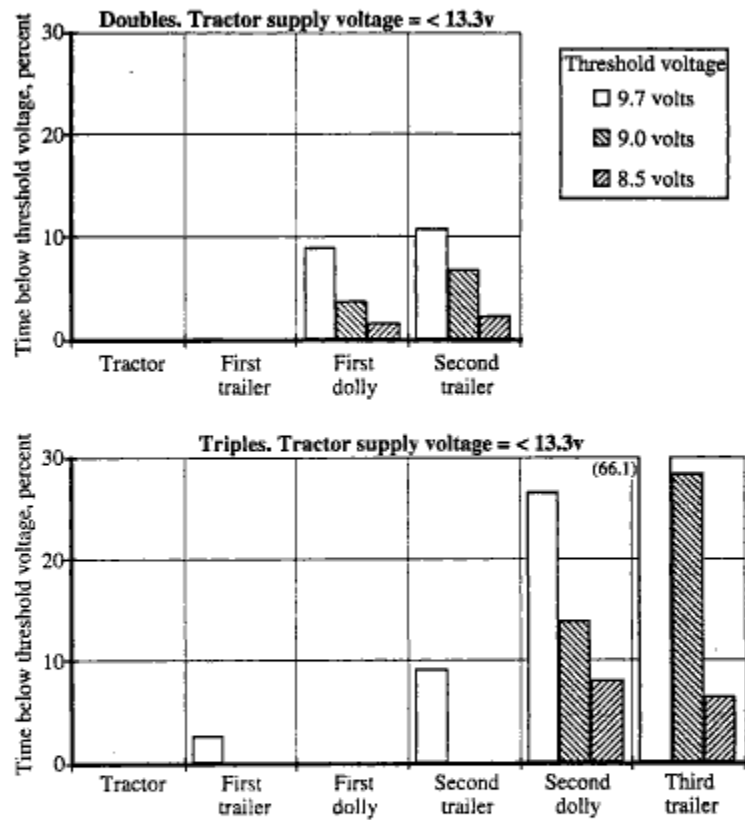

Figure 19. Percentage of time during ABS braking events when the brake-light-circuit voltage was less than the indicated threshold voltage for LCVs with incandescent brake lamps and supply voltages less than 13.3 volts

Puede ser consultado en:

<http://www.hti.umich.edu/cgi/t/text/text-idx?sid=50cf84488b83cc2b8ba0554be1cc5c98;c=umtri;idno=88519.0001.001>

**Table 7. ABS event times for LCVs using incandescent brake lamps and with tractor supply voltages greater than 13.3 volts**

	<i>Tractor</i>	<i>First trailer</i>	<i>First dolly</i>	<i>Second trailer</i>	<i>Second dolly</i>	<i>Third trailer</i>
<b>Doubles with tractor supply voltages greater than 13.3 volts</b>						
<i>Time below 9.7 volts, sec.</i>	0.0	0.0	0.0	0.0		
<i>Time below 9.0 volts, sec.</i>	0.0	0.0	0.0	0.0		
<i>Time below 8.5 volts, sec.</i>	0.0	0.0	0.0	0.0		
<i>Total ABS event time, sec.</i>	7.5	48.7	30.4	31.6		
<b>Triples with tractor supply voltages greater than 13.3 volts</b>						
<i>Time below 9.7 volts, sec.</i>	0.0	0.0	0.0	0.1	0.3	2.2
<i>Time below 9.0 volts, sec.</i>	0.0	0.0	0.0	0.0	0.0	0.0
<i>Time below 8.5 volts, sec.</i>	0.0	0.0	0.0	0.0	0.0	0.0
<i>Total ABS event time, sec.</i>	0.7	8.7	20.8	29.8	21.2	14.4

**Table 8. ABS event times for LCVs using incandescent brake lamps and with tractor supply voltages equal to or less than 13.3 volts**

	<i>Tractor</i>	<i>First trailer</i>	<i>First dolly</i>	<i>Second trailer</i>	<i>Second dolly</i>	<i>Third trailer</i>
<b>Doubles with tractor supply voltages less than 13.3 volts</b>						
<i>Time below 9.7 volts, sec.</i>	0.0	0.1	10.8	8.4		
<i>Time below 9.0 volts, sec.</i>	0.0	0.0	4.5	5.3		
<i>Time below 8.5 volts, sec.</i>	0.0	0.0	2.0	1.8		
<i>Total ABS event time, sec.</i>	22.2	105.8	120.5	77.2		
<b>Triples with tractor supply voltages less than 13.3 volts</b>						
<i>Time below 9.7 volts, sec.</i>	0.0	0.3	0.0	0.6	9.4	10.1
<i>Time below 9.0 volts, sec.</i>	0.0	0.0	0.0	0.0	4.9	4.3
<i>Time below 8.5 volts, sec.</i>	0.0	0.0	0.0	0.0	2.9	1.0
<i>Total ABS event time, sec.</i>	6.0	12.4	18.8	6.6	35.4	15.2

#### *ABS Supply Voltage In Especially Intense Events*

The findings presented to this point in this section are based on the full set of ABS events recorded in the project. The majority of these events are relatively minor and involve minimal ABS activity. On the other hand, the real challenge to powering ABS in LCVs is not in these events, but in those few braking events in which ABS activity is intense and might occur in several units simultaneously.

Therefore, all LCV braking events characterized by (1) tractor supply voltage exceeding 13.3 volts and (2) ABS activity on three or more units were isolated and examined separately in order to challenge and confirm the findings presented above.

Nine individual events were examined. Seven involved triples and two involved doubles. Three of the events on triples were specially *staged* braking events (which have not been considered previously).

The events—and especially the staged events—were, indeed, intense. Figure 20 shows the time histories of brake-light voltage, brake service pressure, and brake chamber pressure from all of the trailers and dollies from one staged event with triples. The vertical separation between the plots of service and chamber pressures shows that ABS were very active on three of these units during most of the event (0.8 to 3.0 seconds). The ABS on the other two units were also active early in the event (0.8 to 1.6 seconds). During this earlier period, the brake-light voltage on the third trailer fell to a minimum of 9.34 volts.

Examination of all of these events, in fact, confirmed the findings from the broader data set (as presented earlier in figure 18). In these special events, ABS voltage was never found to fall below 9.7 volts on doubles or below 9.0 volts on triples. The only observation of ABS supply voltage below 9.7 volts was in the second and third trailers of triples. Over the seven events with triples, the supply voltage was below 9.7 volts for 2 percent of the total event time on second trailers and for 23 percent of the total event time on third trailers. As one would expect, these results were not evenly distributed across the seven events. The time spent below the 9.7 volts was concentrated in three events. The average tractor supply voltages (i.e., averaged over all brake applications in the trip in which the event occurred) for these three events were 13.36, 13.55, and 13.55 volts, respectively. The tractor supply voltages evaluated in *these specific three events* (prior to ABS activity, for example prior to 0.6 seconds in figure 20) were 13.48, 13.51, and 13.48 volts, respectively.

The most severe events examined here could be considered to approach a worst-case scenario with respect to electrical current demands on the brake-light circuit. Readers familiar with the details of ABS operation (especially with the peak current demands of modulator valves which occur upon initial actuation) may be surprised that the voltage

Puede ser consultado en:

<http://www.hti.umich.edu/cgi/t/text/text-idx?sid=50cf84488b83cc2b8ba0554be1cc5c98;c=umtri;idno=88519.0001.001>

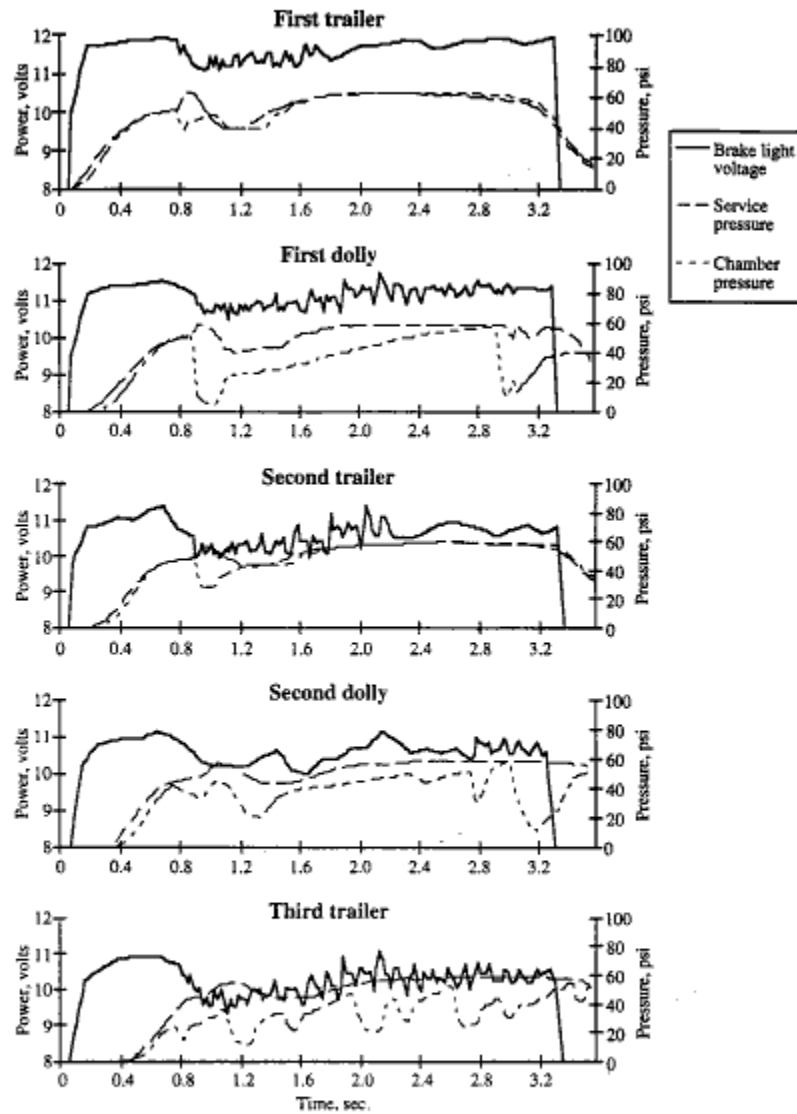

Figure 20. ABS supply voltages and brake system pressures during an intense ABS braking event



supply to the last trailer is so consistently above the ABS thresholds. The authors believe that the basic fact underlying this result is simply that *truly* simultaneous firing of the several modulator valves throughout the vehicle is rare. Thus, the *absolutely* worst-case scenario of the peak current demand associated with all valves firing simultaneously is also rare.

#### **Summary Of Findings On Powering ABS On LCVs Through The Brake-Light Circuit**

Based on these observations of ABS braking events, it appears that the brake-light circuit can supply sufficient voltage for operation of ABS on LCVs *if* the following conditions are met:

- the tractor supply voltage exceeds 13.3 volts
- tractors and trailers are equipped with heavy gage wiring and circuit elements of capacities similar to those in this study
- heavy-duty, seven-wire jumper cables are used and connectors and receptacles are maintained in good condition
- ABS voltage requirements do not exceed 9.0 volts

The focus of the preceding discussion has been on brake-light-circuit voltages on vehicles using incandescent brake lights. The brake-light-circuit voltages found on LCVs with LED stop lights were high enough that ABS supply voltage was virtually always adequate in both double- or triple-trailer combinations regardless of the tractor supply voltage (down to the minimum tractor supply voltage of 12 volts observed in this study). While the effect of LED stop lights on brake-light-circuit voltage is significant, the reader should keep in mind that these results were observed only under conditions that include the heavy-duty and supplemental wiring already discussed.

#### **CHARACTERIZATION OF THE LONGITUDINAL BEHAVIOR OF LCVS**

Much of the data gathered in this field study for the purpose of examining ABS performance are also useful for describing the general longitudinal performance of LCVs. This section presents analyses intended to do that. Specifically, the following items will be presented.

- the distribution of travel time by configuration and speed
- the distribution of brake application time by configuration and speed
- the number of brake applications per mile by configuration and load condition
- the distribution of brake application pressure and longitudinal deceleration by speed, configuration and load condition

**Distribution Of Travel Time**

Figure 21 shows the distribution of travel accumulated at low (0 to 25 mph), medium (25 to 45 mph), and higher (above 45 mph) speeds as a function of vehicle configuration. The measure is in *minutes* per hour. This statistic shows that, on average, each configuration examined spends nearly fifty minutes per hour of travel (80 percent) at speeds of 45 mph or more. This is so despite the probability of some bias in the quality of routes of traveled. (That is, doubles generally traveled two-lane roads for a larger fraction of the time since triples are more confined to interstate highways.)

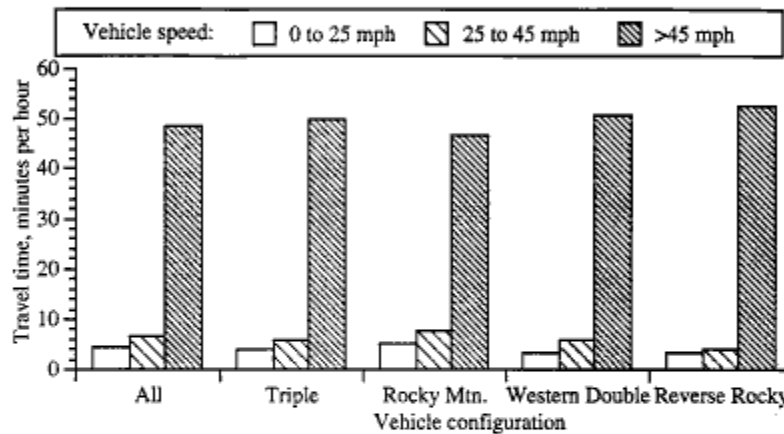

**Figure 21. Distribution of travel time by configuration and speed**

Figure 22 shows a similar distribution of the time spent while applying the brakes. The figure shows the number of *seconds* per hour of travel that the brakes were applied as a function of configuration and speed. Although these results are not as uniform across configuration as those of figure 21, they generally show that, regardless of configuration, LCV drivers spend approximately the same amount of time braking in each of the three velocity ranges. Summing across all velocities, brakes are applied about 108 seconds per hour (3 percent), on average.

**Brake Applications Per Mile**

Another simple statistic derived from the electronic data was the number of brake applications per mile. Table 9 presents this measure, and associated data, for all the LCVs of the study. The presentation distinguishes between doubles or triples and by loading condition.

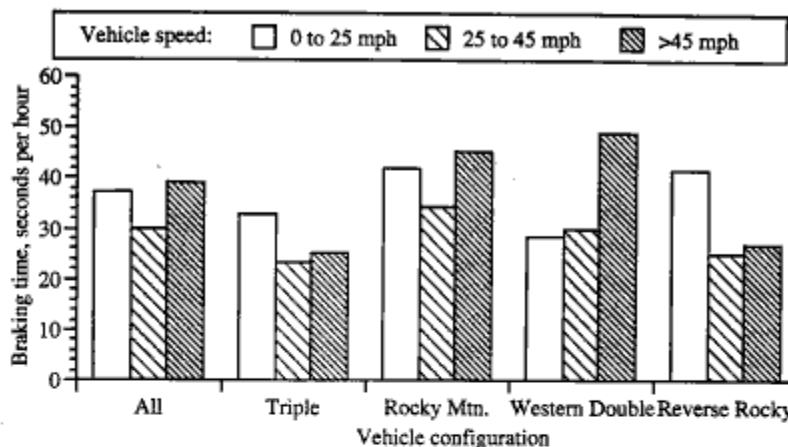

Figure 22. Distribution of brake application time by configuration and speed

On average, the LCVs of this study experienced 0.30 brake applications per mile. Triples, however, averaged considerably fewer applications per mile (0.19) than did doubles (0.34). This may be due to the restricted operations of triples. Most states that allow triples (including those in which the field study took place), restrict the operations of these vehicles to specific highways, better weather conditions, and/or times of lesser traffic congestion. These more benign operating conditions may be the reason for the lower rates of brake applications for these vehicles.

The data for empty vehicles also show a lower number of brake applications per mile than are apparent for loaded vehicles. This may be due to the fact that retardation mechanisms such as engine braking, rolling resistance, and aerodynamic losses, produce greater deceleration of the empty vehicle than of the loaded vehicle, reducing the relative need for brake application.

Table 9. Statistics describing brake applications per mile for different configurations and load conditions

	Mean Brake App./Mile	Number of Brake App.	Total Miles	Number of Trips
All	0.30	75,255	286,009	747
Doubles	0.34	61,138	205,856	554
Triples	0.19	14,117	80,153	193
Empty	0.26	27,125	121,747	310
Full	0.34	44,168	146,201	391

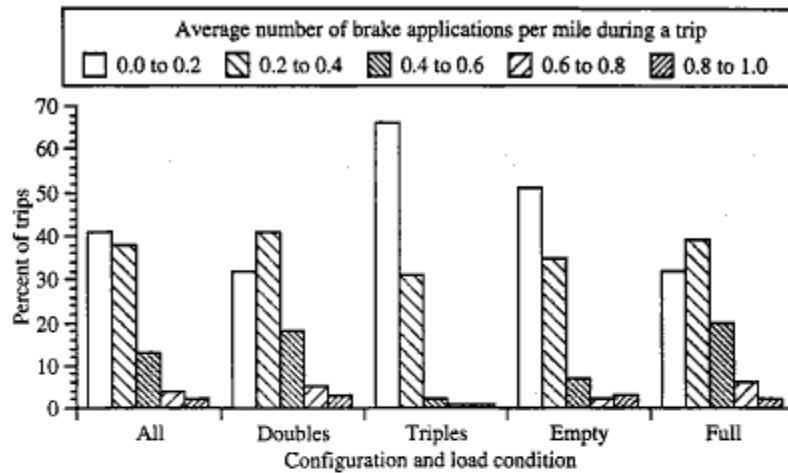

**Figure 23. Distribution of brake applications per mile by configuration and load condition**

Figure 23 provides more insight into the number of brake application per mile by examining the data on a trip-by-trip basis. The average number of brake applications per mile was determined for each trip. These results are plotted to show the percentage of trips in which the average number of brake applications per mile fell into the several ranges indicated (by shading). This is again done for all vehicles, for doubles and for triples, and for empty and loaded vehicles.

Figure 23 suggests that the majority of individual trips are characterized by brake application rates per mile that are less than the average rate for all trips. Said in another way, the average rate of brake applications per mile (for all trips) appears to be elevated by a few trips in which a great deal of braking is done.

#### **Brake Application Pressure**

The instrumentation systems monitored the air pressure in the service brake line at all times that the brake-light voltage indicated that brakes were being applied. The measured pressures were not recorded continuously, but were used to generate histograms of brake application pressure on line in the loggers on the vehicle. These histograms covered seven ranges of brake application pressure. That is, the cumulative times spent with brake pressure applied within these seven specified ranges was recorded. These data were further subdivided according to the vehicle speed, such that individual histograms were produced for eight ranges of vehicle speed. (See appendix B for details on pressure and velocity ranges.)

An extensive set of the resulting histograms is presented in appendix I. For review here, the histogram data are reduced to the average brake application pressure as a function of vehicle speed. This is done for different configurations and load conditions.

The average brake application pressure for each velocity is calculated as follows:

$$P_{avg} = [\sum(t_i \times P_i)] / [\sum t_i] \quad (1)$$

where  $P_{avg}$  is average pressure

$t_i$  is the cumulated time of the  $i^{th}$  histogram matrix position

$P_i$  is the center of the pressure range of the  $i^{th}$  histogram matrix position and the summations take place over values of  $i$  representing all pressure ranges for the velocity of interest.

These calculations were done for the brake-pressure histograms of the tractors. Results are shown in the figures 24 and 25 for different load conditions and configurations.

Figure 24 shows the average brake pressure as a function of vehicle speed for different load conditions. The general shape of the curves in the figure shows that drivers tend to apply the brakes harder at lower speeds than at higher speeds. For all load conditions, drivers tend to use the highest brake pressure when traveling between 15 and 25 mph. This may suggest that, during the approach to a stop, it is in this speed range that the driver corrects speed to achieve an accurate positioning of the vehicle at the completion of the stop.

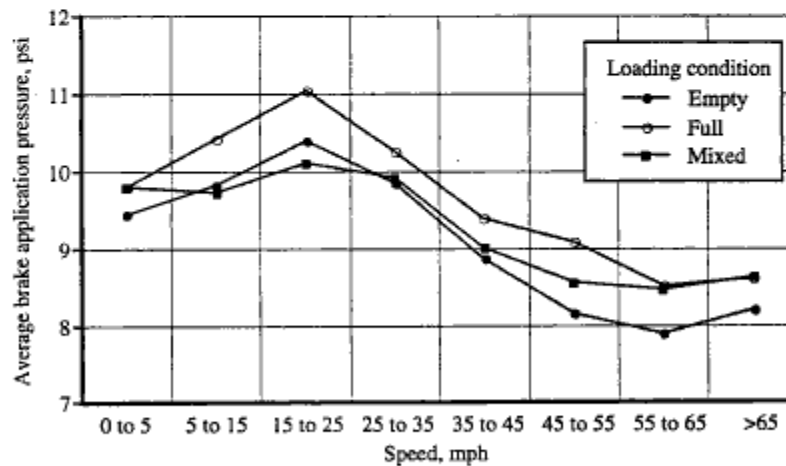

Figure 24. Average brake application pressure as a function of speed for different load conditions

At higher speeds, drivers tend to use lower air pressures. At velocities above 45 mph, the average brake pressure is between eight and nine psi, which is only a few psi above the so-called pushout pressure (the pressure at which the brake friction material actually engages the drum). Not surprisingly, drivers appear to be more cautious when braking at higher speeds—and observation that was also supported by the very low incidence of ABS cyclical events at speeds above 45 mph as shown in figure 10.

The relative levels of brake pressure for the empty and full load conditions are as one would expect. Mean brake pressures for the fully loaded vehicles are consistently higher than those for the empty vehicle. The form of the two curves across all velocities is remarkably similar. In contrast to the fixed relation between the curves for the empty and loaded vehicles, the curve for the mixed loading condition is somewhat erratic. This may be related to the more difficult braking task which the driver must address when there is a mix of loaded and empty trailers in the vehicle.

Figure 25 shows the average brake application pressure as a function of speed for double and triple trailer combinations. These data show that, at low and moderate speeds, drivers tend to apply higher pressures when operating triples than when operating doubles.

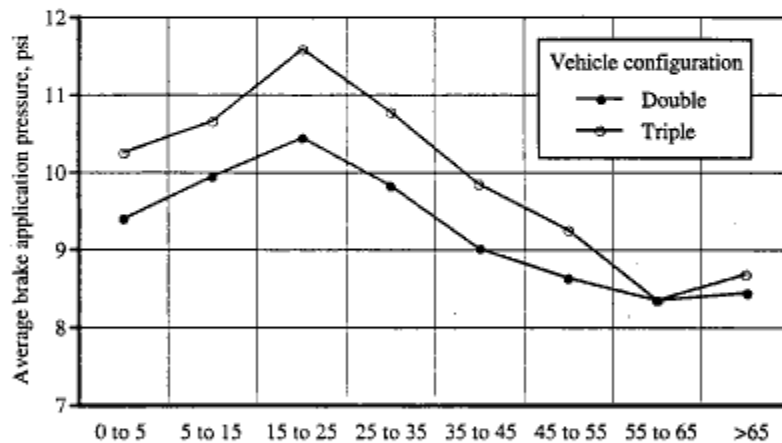
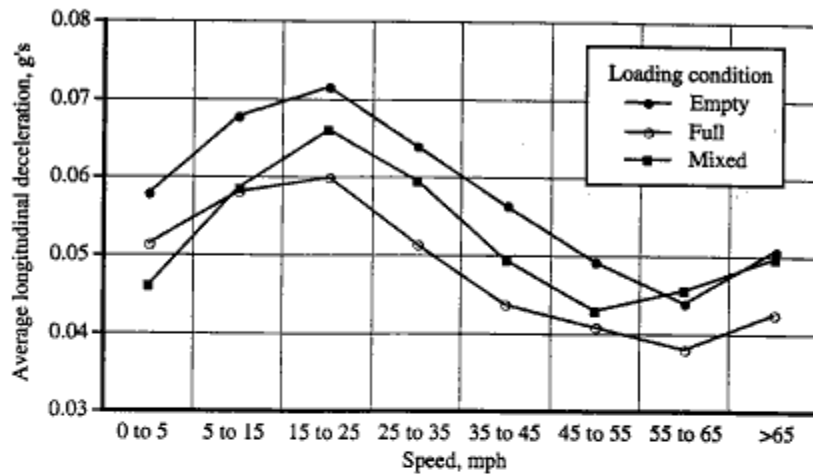

Figure 25. Average brake application pressure as a function of speed for double- and triple-trailer LCVs

#### Longitudinal Deceleration

The electronic monitoring equipment also measured the longitudinal deceleration characteristics of the LCVs. Longitudinal accelerometers were installed on all seventeen tractors. Signals from these instruments were used to create histograms of the same two-dimensional form as those described for brake pressure. (See appendix J.) Average



**Figure 26. Average longitudinal deceleration as a function of speed for different load conditions**

deceleration was calculated from these data in the same manner as described for the calculation of average brake pressure.

Figure 26 shows average longitudinal deceleration as a function of speed for different load conditions. As expected, these curves are similar in form to those for brake application pressure, except that the relationship between the curves for full and empty vehicles is reversed. This is consistent with the fact that full vehicles are heavier and therefore required greater brake pressures to achieve the same level of deceleration as an empty vehicle. It also appears to suggest that drivers are more cautious when braking loaded vehicles than when braking empty vehicles.

Figure 27 shows the longitudinal deceleration experience for doubles and triples. This figure shows the rather surprising result that drivers in this study tended to brake triples somewhat more aggressively than doubles, particularly at lower speeds.



Puede ser consultado en:

<http://www.hti.umich.edu/cgi/t/text/text-idx?sid=50cf84488b83cc2b8ba0554be1cc5c98;c=umtri;idno=88519.0001.001>

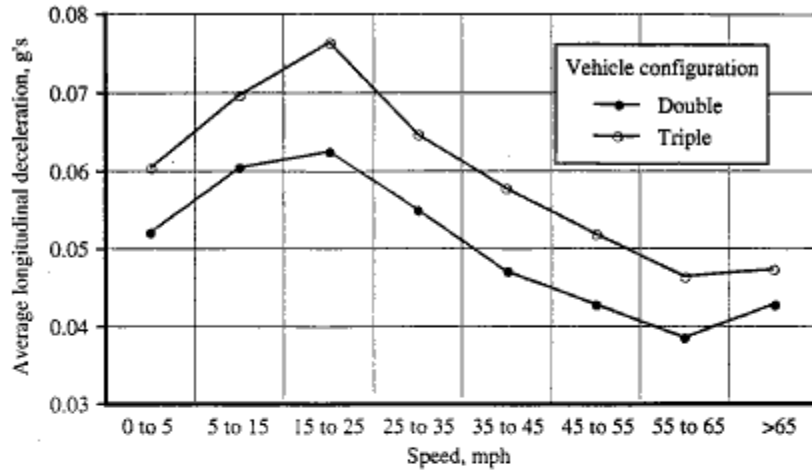

Figure 27. Average longitudinal deceleration as a function of speed for double and triple trailer LCVs

### **MAINTENANCE, RELIABILITY, AND OPERATING COSTS OF ANTILOCK BRAKING SYSTEMS ON LCVS**

The observations made in this LCV field study suggest that introducing ABS on all units of a typical double- or triple-trailer combination vehicle would increase the maintenance expense of the entire vehicle by about 1 percent. The cost of maintaining ABS on trailers and dollies appears to be about 3.2 cents per one hundred miles traveled per unit. This represents about 1 percent of the maintenance costs of a trailer and about 3 percent of those costs for a dolly. The figures for tractors are 4.5 cents per one hundred miles and 1.5 percent of maintenance expenses of the unit. At the same time, ABS can prevent costs incurred through tire flat spotting. Actual savings could not be established, since it was not possible to determine a reference cost for tire flat spotting experienced without ABS. However, 131 individual units accumulated a total of 10.5 million unit-miles in this study without the loss of any tires to flat spotting which occurred in normal or emergency braking.<sup>19</sup>

A summary of the maintenance costs of ABS in the context of the costs for the entire LCV (and, in particular, costs for trailers and dollies) is presented in the following section. The next section will consider the effect of ABS on flat spotting of tires. Then, the ABS maintenance experience of the 131 vehicle units in this study will be discussed in detail. This section will include comparisons with the results of previous field studies conducted by the NHTSA, which examined ABS use on tractors and on semitrailers.[2,3] In the context of this chapter on ABS, the expenses related to other systems of trailers and dollies are presented in summary form for reference but are not considered in detail. However, an extensive review of all *dolly* systems and their costs does appear in the chapter of this report on maintenance, reliability, and operating costs of C-dollies. (For a review, see the section on tire costs and see figure 49 and table 20 of that chapter.) A brief discussion of the sources of the reference costs of maintenance of other systems of trailers is presented in appendix K.

### **SUMMARY OF THE MAINTENANCE COSTS OF ABS ON LCVS**

Figure 28 presents the continuing maintenance costs for typical double-trailer and triple-trailer LCVs with and without ABS as determined in this study. (These values include the unscheduled maintenance costs for all systems, but do not include the costs of regularly scheduled periodic and annual inspections.) The increase in cost associated with ABS is difficult to determine from this figure since it amounts to a change of only 1 percent. The differences are more apparent in table 10 where cost figures are presented in tabular form,

<sup>19</sup> Frozen brakes did account for the loss of four tires to flat spotting during the study.

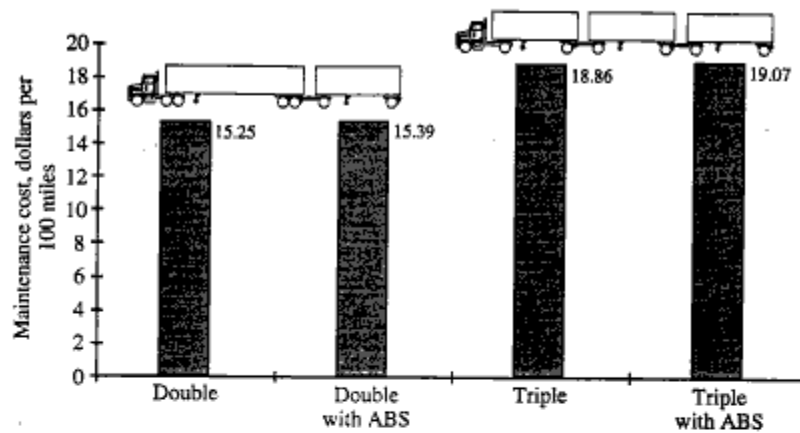

Figure 28. Maintenance costs for LCVs with and without ABS

and a distinction is made between the maintenance costs for ABS and for all other systems of the vehicle.

Table 11 provides more detail by presenting maintenance costs for individual types of units. Costs for ABS and for all other systems are again separated. The cost of maintaining ABS on tractors is \$0.045 per 100 miles or about 0.5 percent of the maintenance expense for the unit. Maintaining ABS on a typical trailer or dolly requires an expenditure of \$0.032 per 100 miles, which is 1.2 percent of the total maintenance cost of a trailer and 3.0 percent of the maintenance cost of an A-dolly.

Table 10. Maintenance costs of ABS and other systems on LCVs

Cost, dollars per 100 miles for:	Double	Triple
ABS	0.141	0.205
All other systems <sup>†</sup>	15.247	18.863
Total	15.388	19.068

Table 11. Maintenance costs for individual units

Cost, dollars per 100 miles for:	Tractors	Trailers	Dollies
ABS	0.045	0.032	0.032
All other systems <sup>†</sup>	9.048	2.582	1.034
Total	9.093	2.614	1.066

<sup>†</sup> These costs do not include the expense of periodic and annual inspection on trailers and dollies.

**The Cost Of ABS On Trailers And Dollies In Comparison To The Total Maintenance Costs Of These Units**

Figure 29 shows a complete summary picture of the representative maintenance costs for trailers and for dollies, respectively, as determined by all the data sources considered in this study. This figure reveals that ABS is the least expensive system of the unit to maintain when compared with seven other categories of maintenance items into which all other maintenance expenses are divided.

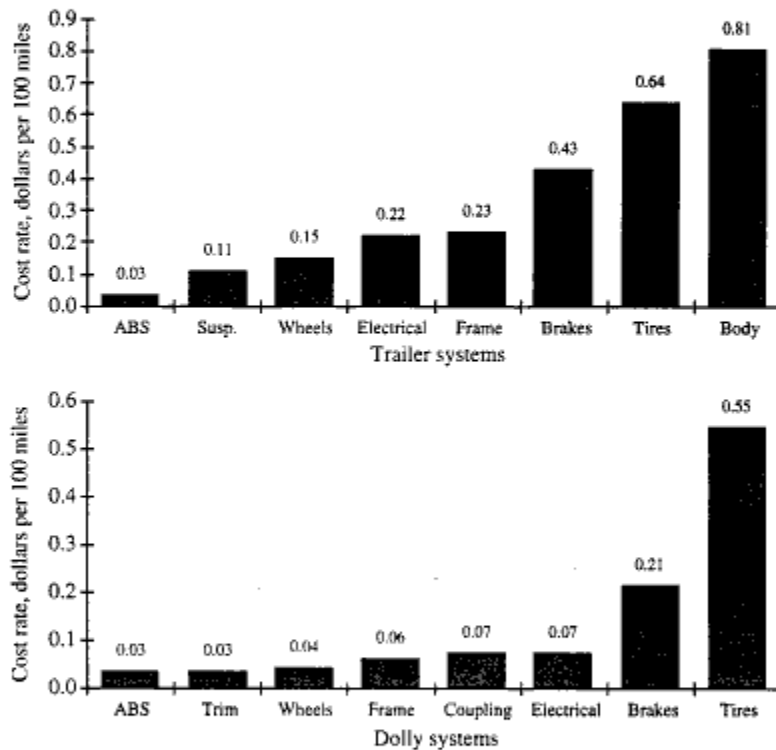

**Figure 29. Maintenance cost rates for ABS and other systems for trailers and for dollies**

Figure 30 presents a comparison between the maintenance experience of ABS and of other trailer systems. The figure includes results from both this study and a previous field

study of semitrailers conducted for the NHTSA.[3]<sup>20</sup> For systems other than ABS, the values shown as "LCV study" derive from the historical records of twenty-four single-axle and tandem-axle van trailers in this study. These rates were calculated from records collected over 4.5 million miles of use for these units. The results of both studies show that ABS repairs occur less frequently than repairs for any of the other trailer systems shown.

A review of the data and analyses that lead to figures presented in this summary follow after a brief discussion of the observations regarding the influence of ABS performance on tire costs.

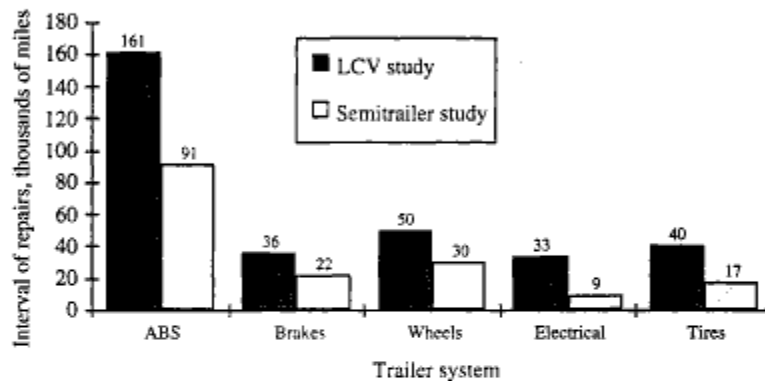

Figure 30. Intervals of repairs for ABS and other trailer systems from the LCV study and a previous semitrailer study

### ABS AND THE FLAT SPOTTING OF TIRES

This project provides substantive evidence that ABS can largely eliminate flat spotting due to wheel lock during braking. During this study, the 131 individual units accumulated a total of 10.5 million unit-miles; drivers submitted sixty-three reports of significant braking events; several other very severe braking events were purposefully undertaken with vehicles participating in the study. Nevertheless, monthly tire tread assessments conducted throughout the study revealed no clearly visible tire flat spots, nor did the tire maintenance records of the fleets reveal any tire changes due to flat spotting resulting from either normal or severe braking.

ABS did not *completely* eliminate tire flat spotting, however. Four tires from LCV study units were lost to flat spotting as the result of two separate events. Both cases

<sup>20</sup> Figure 3.9. "Comparison of Miles Traveled Between Repair/Replacement Maintenance Incidents, for ABS and Other Major Vehicle Components, in the Test Fleet of 50 ABS-Equipped Vehicles", page 3-21.

occurred in cold weather when a "frozen" brake failed to release as the vehicle was pulling away from a standing position. The respective drivers were apparently unaware of their situations and continued for sufficient distances to ruin the two sets of tires involved.<sup>21</sup>

An objective measure of the cost savings resulting from the reduction of tire flat spotting could not be determined in this study. Prior to this project, none of the participating fleets maintained records of the replacement of trailer or dolly tires in a manner that would allow differentiating between replacement for normal wear and replacement for flat spotting. Thus, the reference cost necessary to determine savings could not be established.<sup>22</sup>

It is probably most useful to simply note that the experience of this study suggests that the costs associated with tire flat spotting can be largely eliminated through the use of ABS. Those operators who do know the cost burden they bear due to flat spotting can then evaluate this result in light of their own situation.

#### **RELIABILITY, DURABILITY, AND MAINTENANCE COSTS OF ABS**

All work orders and maintenance records for the 131 units in the LCV field study (seventeen tractors, eighty-six trailers, twenty-eight dollies) were collected from August 1993 through April 1995. These records became the basis for evaluating the reliability and maintenance costs of ABS on tractors, trailers, and dollies. In total, these 131 units accumulated over 10.5 million miles of service, and at the conclusion of the program, a total of seventy-one ABS problems had been reported.

Fifteen of these problems (21 percent) were classified as related to warranty service or to the installation procedures carried out in this study. These problems are treated separately in the first subsection that follows, as it is not appropriate to associate them with the expenses of *continuing maintenance*.

The remaining fifty-six problems were classified as in-service and, thus, contribute to maintenance expense of the vehicles. Forty-two of these (59 percent) occurred on trailers and dollies and fourteen (20 percent) on tractors. The second subsection is a detailed

---

<sup>21</sup> It has been speculated that ABS could reduce flat spotting from this type of event also. The theory is that, under this type of condition, the ABS diagnostic system should detect the locked wheel, light the warning lamp, and alert the driver to the problem. However, in this study, ABS on trailers and dollies were powered through the stop-light circuit such that the systems would not typically be powered during this type of event.

<sup>22</sup> Informally, managers of several of the participating fleets indicated that they did believe that the costs associated with flat spotting were significant, some quoting substantial percentages of all tire costs.

discussion of ABS problems found on trailers and dollies. Finally, a subsection on the problems that occurred on tractors is presented.<sup>23</sup>

Results for trailers and for dollies are considered together, largely because the ABS used on each of these are so similar. Further, the sample size of dollies taken alone in this project does not justify their separate treatment in this regard. ABS maintenance is treated separately for tractors because these systems differ so much from trailer and dolly systems. Other qualities of the study fleet that are of interest include the following.

- Mileage accumulated during this program was markedly different for powered and non powered units. Tractors averaged approximately 221,000 miles per unit, while trailers and dollies averaged only 59,000 miles per unit.
- The ABS were powered differently on tractors than on trailers and dollies. Tractor ABS was, of course, powered full time, while ABS on trailers and dollies were powered only when the brake-lamp circuit was energized.
- The seventeen tractors were a diverse mix of eleven new units with ABS installed at the factory, four older units, also with factory-installed ABS, and two older units which had ABS retrofitted for this study. Of the trailers and dollies, twenty-five (mostly dollies) were new with ABS installed by the manufacturer, and eighty-nine were used with ABS retrofitted for the study.

#### **Problems Related To The Design And Installation Of ABS On Trailers And Dollies**

There were fifteen repairs of ABS on trailers and dollies that could be directly attributed to design deficiencies or to oversights during the installation process. These problems are viewed as warranty issues and their costs are not included in the costs of continuing maintenance. Four of these were related to cables and connectors, and eleven involved the ECU. Also, there was a recall issued during the study for the twenty Bendix MC-12 ABS units used in the study.

The total cost of the problems related to design and installation (including the recall) was \$11,112.10 in parts and labor. Of these costs, \$9,651.25 (87 percent) were a result of design problems which, in normal operations, would have been covered by warranty. (Seventy percent of the total was related to the Allied Signal recall.) The remainder involved problems that were peculiar to the retrofitting or other elements of the startup of the field study. None of these costs were ascribed to the expense of continuing maintenance.

The cost per unit for the ABS design and installation problems was \$97.47 in parts and labor. This is substantially more than the \$65.36 per unit found in the previous study of

---

<sup>23</sup> In light of the facts that the first of NHTSA's three field studies followed 200 tractors and that only seventeen tractors were included in this study, considerably greater emphasis is placed on trailers and dollies than on tractors in this discussion.



ABS-related cost for semitrailers.[3] When the costs associated with the recall are removed from the total, however, the cost per unit is reduced to \$29.93.

The details of these fifteen ABS repairs and the recall are discussed below.

#### *Cables and connectors*

Four of the startup problems involved cables and connectors. Two of these occurred on trailers and were a result of incorrect wiring of the status light during the installation process. In one case, the status light was incorrectly wired on a new trailer at the factory. The other wiring mistake was made during the retrofitting of ABS on a trailer.

The third problem also occurred during the retrofit installation of ABS. In this case, screws used to mount quarter fenders on a dolly pierced the status light wire causing an electrical short.

The fourth problem occurred early in the study and was reported by a driver who thought the ABS status light was not functioning correctly. The trailer was returned to the shop that had performed the retrofitting, and a loose power lead and two wheel-speed sensor wires were replaced. Further investigation revealed that the problem was actually due to driver misunderstanding, not the ABS, and that the wires had been damaged by fleet maintenance personnel before the trailer was returned to the shop. The total cost to correct this non problem was \$395. This is a good example of the importance of thorough ABS training for fleet personnel.

The total cost to correct these four problems was \$453.55.

#### *Electronic control units*

There was a total of eleven problems involving the ECU of the ABS. These problems were distributed among all three brands of ABS in the study. The details of these problems are given below:

- Two of the ECU problems resulted from improper configuration of the systems during installation. To correct these problems, the two ECUs had to have all fault codes cleared from memory and the system properly reconfigured. The total cost to make these changes was \$20.30.
- The ECUs on the study dollies of one of the participating fleets were mounted in a vulnerable location. As a result, these units were subject to mechanical damage during "stacking" of the dollies at the distribution terminal. Three months after the start of the program, an ECU at this fleet was replaced due to yard damage. Shortly thereafter, the fleet maintenance personnel relocated all the ECUs on these units. The total cost to replace one ECU and relocate the ECUs on six dollies was \$952.00. These problems were classified as installation problems because they

involved changes that probably would not have occurred if the fleet had purchased the ABS and specified the ECU location themselves.

- Two ECU failures were attributed to moisture contamination inside the ECU enclosure. Both problems occurred on Midland-Grau systems and were manifest in the occurrence of a "communication fault between the dual microprocessors."<sup>24</sup> The first problem occurred after a year of service and the second occurred near the end of the program. Midland-Grau reported that changes were made to the ECU enclosure to prevent moisture from entering. At the conclusion of the program, Midland-Grau noted that they are now marketing a newer version of their ABS which has a sealed ECU. The total cost to repair these two problems was \$752.50.
- Three ECU failures were a result of inadequate surge protection in the Midland-Grau system. Two of the failures occurred early in the study and the third near the end of the program. Midland-Grau indicated that there was inadequate surge protection on the status-light circuit and supply-voltage spikes could harm this circuit. Midland-Grau also indicates that changes to the design of their ECU have addressed this problem. The total cost to repair these three problems was \$1,198.75.
- The remaining two problems with ECUs occurred on dollies and appear to have been caused by improper installation of the ECUs during the Allied Signal recall campaign. These problems were not identified until very late in the program and testing was completed before they were actually resolved. When these ECUs were removed from the dollies and tested, they showed no fault codes. Allied Signal concluded that some error in installation or hookup caused the problem. Fortunately, these units did not accumulate much mileage following the installation of the new ECUs. Based on the hubometer readings, these ECUs were inoperable for approximately 850 miles. The total cost to inspect these units was \$35.

#### *Electronic control unit recall*

Allied Signal issued a recall of the Bendix ABS MC-12 antilock modulator controllers during the study. According to correspondence from Allied Signal dated September 30, 1994, a rubber part in the valve was subject to swelling upon prolonged exposure to various types of alcohol and antifreeze. Such swelling could restrict or block air passage within the assembly and, if excessive, could result in loss of braking. Replacement controllers with inert (silicone) seals were provided under the recall. This recall affected twenty (18 percent) of the 114 trailers and dollies involved in the study. The cost of replacing all the recalled ECUs was paid for by Allied Signal, but was estimated at \$7,700.00 in parts and labor.

<sup>24</sup> When a faulty ECU was replaced, the original unit was sent to its manufacturer for a diagnosis of the failure.

**Maintenance Of ABS On Trailers And Dollies During The Field Study**

The 114 trailers and dollies of the field study experienced a total of forty-two in-service ABS problems. These forty-two problems were concentrated on thirty-one (27 percent) of the units. The forty-two problems resulted in total repair costs of \$2,180.55 or an average cost of \$51.92 per event. Averaged over all the 114 units, the cost was \$19.13 per unit. Given that these units traveled 6.7 million miles in the study, the maintenance cost per 100 miles (CPCM) of operation was \$0.032.

Table 12 summarizes the distribution of these maintenance events and costs according to the component of ABS at fault. A discussion of each class of problems follows.

**Table 12. Summary of ABS maintenance problems and costs for 114 trailers and dollies**

<i>Component</i>	<i>No. of Problems</i>	<i>Labor Time (hrs)</i>	<i>Labor Costs (\$)</i>	<i>Parts Costs (\$)</i>	<i>Total Cost (\$)</i>	<i>Cost per Unit (\$)</i>	<i>Cost/100 Miles (\$)</i>
<i>Cables/Connectors</i>	7	5.8	204.05	0.00	204.05	1.79	0.003
<i>ECU</i>	2	3.0	105.00	700.00	805.00	7.06	0.012
<i>Inspection - NPF</i>	18	9.0	315.00	0.00	315.00	2.76	0.005
<i>Modulator Valves</i>	1	1.0	35.00	350.00	385.00	3.38	0.006
<i>Speed Sensors</i>	5	2.5	87.50	80.00	167.50	1.47	0.002
<i>Status light</i>	9	7.4	259.00	45.00	304.00	2.67	0.005
<i>Total</i>	42	29.0	1005.55	1175.00	2180.55	19.13	0.032

*Cable and connectors*

There were seven problems associated with cables and connectors. These problems required a total of 5.8 labor hours to repair and total costs were \$204.05 for an average of \$1.79 per unit. The CPCM for these problems was \$0.003.

These problems fell into two groups. The first group was composed of four problems involving damage to wires: one power harness, one wheel-speed sensor wire, and two status-light wires. The total cost to diagnose and repair these four problems was \$151.55.

The repairs to the status-light wires and to the power harness are noteworthy. In both status-light repairs, the wire was sheared near the fifth-wheel plate on trailers. It is likely that these problems were caused by road debris or by tire chains on the tractor drive wheels. These two problems highlight the need to protect wires that pass near or above tires. The damage to the harness was caused when it was crushed during maintenance service on a different system.

ESTUDIO DE INVESTIGACIÓN DE LA UNIVERSIDAD DE MICHIGAN  
Puede ser consultado en:

<http://www.hti.umich.edu/cgi/t/text/text-idx?sid=50cf84488b83cc2b8ba0554be1cc5c98;c=umtri;idno=88519.0001.001>

The remaining three problems with cables and connectors are best described as loose or poor wire connections. They involved connectors at a wheel-speed sensor, an ABS status light, and an ECU. Each problem was corrected when the suspected connector was loosened and resecured. The total cost to repair these three problems was \$52.50.

*Electronic control unit*

There were two problems associated with the electronic control units. These problems required 3.0 labor hours and \$700.00 in replacement parts to repair. This class of problem had a total cost of \$805.00 (\$7.06 per unit) and was the most expensive type of maintenance problem. The CPCM for the ECU problems was \$0.012 and constituted 37 percent of all ABS maintenance costs.

The electronic control units are the "brains" of the ABS, and like many complex electronic devices, field repair is not a viable option. Thus, in both cases the ECUs were replaced with new units. The first problem occurred with a unit from Midland-Grau, and their diagnosis was that it resulted from a failed diode. They also noted that there was no apparent reason for the failure and no prior history of similar failures. The second problem occurred with a Bendix ECU. The cause of the failure, as reported by Allied Signal, was a bad solder joint at a capacitor connection. No other problems of this nature occurred during the program.

*Inspection - No problem found*

There were eighteen ABS problems reported in which no malfunction could be detected and no repair was necessary. These problems did require effort on the part of maintenance personnel, and an estimated general inspection time of 0.5 labor hours was specified for this type of problem. The problems required a total of 9.0 labor hours to inspect and had a cost of \$315.00 (\$1.79 per unit). The CPCM for this category of problems was \$0.005.

These problems clearly fell into three distinct groups. The first and largest group involved ten reports related to drivers who did not understand the status-light function. Six of these ten problems occurred at fleets that had more than one brand of ABS installed on their units. Because the status lights are used by drivers to diagnose the ABS, a clear understanding of their operation is critical. The Bendix status light functions differently than the light on the WABCO and Midland-Grau systems, and this apparently caused confusion among new drivers. *These problems underscore the desirability of thorough driver training and a standard agreement on status-light function.*

There was one report by a driver involving status-light function for which no substantive problem could be identified. This event could not be explained by inadequate training since the driver was experienced with ABS and the report was filed after his twenty-eighth trip during the field study. Following the report, the unit was closely monitored, and no further problems were reported.

Seven of the reports for which no problem could be identified involved complaints of wheel lock-up on trailers and dollies. Six of these problems involved trailers or dollies using the Bendix system. To better understand how this system worked, some informal braking tests were conducted by the fleet involved. The local Allied Signal representative participated in this activity. The tests showed that the Bendix ABS on the trailers and dollies did allow momentary wheel lock during severe braking, but Allied Signal asserts that this is characteristic of the proper operation of the system. No true defects were found. Driver reports of lock-up apparently referred to this normal performance. Investigation of the seventh problem showed that the ABS was working correctly, but that an ECU fault code reporting wheel-speed sensor fault was present. Twenty days later, this unit was serviced for a wheel-speed sensor problem. (This problem was accounted for separately.)

#### *Modulator valves*

There was one failure of a Bendix ABS modulator valve during the program. The valve was removed, inspected and found to deliver air at reduced rates because of contaminants inside the unit. This fleet used in-line antifreeze, a practice which is discouraged by Allied Signal because of the possibility of damage to rubber components. Allied Signal indicated that this incident played a role in their decision to recall their modulator valves. The cost to replace this valve was \$385. This high figure is due in part to the fact that the ECU and modulator valve are one unit in the Bendix system.

#### *Wheel-speed sensors*

There were five problems with wheel-speed sensors during the program. The problems required a total of 2.5 labor hours to repair and had a cost of \$167.50 (\$1.47 per unit). The CPCM for speed sensors was \$0.003.

All the problems were identified by the internal diagnostic systems of the three brands of ABS. Three of the problems were related to an excessive gap between the sensor and the exciter ring. In one case the unit ran in snow conditions for about sixty miles prior to the status light illuminating. Comments by the repair personnel indicated that snow may have packed around the sensor and caused the system to indicate a fault. The second problem resulted from an accidental disturbance of the wheel-speed sensors during a brake overhaul. No specific cause could be identified for the third problem in this group.

The remaining two problems with wheel-speed sensors were discovered after the completion of testing. In both cases, a representative from Rockwell WABCO checked the ABS and found and replaced a failed wheel-speed sensor. One of the failures was caused by a severed lead wire to the sensor. The exact reasons for the other failure could not be resolved.<sup>25</sup>

<sup>25</sup> The report from the Rockwell WABCO representative on this problem did indicate that the wheel-speed sensor wire was installed incorrectly such that it came taut when the axle moved up and down. If

### *Status light*

There were nine problems with the status light during the program which had a total cost of \$304.00 (\$2.67 per unit). The CPCM for these problems were \$0.005.

Four of these problems involved simply replacing the lamp. Three were a result of mechanical damage to the status-light assembly and required the installation of a new assembly. One problem involved correcting an earlier repair to the unit in which the electrical ground had been improperly installed. The last problem involved replacing a faulty status-light assembly.

### **Comparison With Results Of A Previous Study Of The Maintenance Costs Of ABS On Semitrailers**

Twenty-seven percent of the trailers and dollies of this field study required ABS maintenance in comparison with the results of the previous study in which 63 percent of the semitrailers involved required similar ABS maintenance.[3] Similarly, there were 0.37 repairs per unit during this program as opposed to 0.88 repairs per unit in the previous study. However, it should be noted that the previous study covered two years, whereas the average duration for the five fleets in this study was seventy-seven weeks, or 1.5 years. If the results of the current study were projected linearly to two years, a total of fifty-six problems would be predicted. This would increase the number of problems per unit from 0.37 to 0.49. All of this suggests some improvement in the reliability of ABS over the intervening time period.

The trailers and dollies of the study required an average of \$19.13 per unit to correct in-service ABS problems. This also compares favorably to the semitrailer study in which the costs related to the maintenance of ABS were \$35.27 per unit. Neither these costs, nor the costs in the discussion below on ABS maintenance, include the labor costs associated with scheduled annual and periodic maintenance.

A more meaningful way to compare the results of this study with those of the previous study of fifty semitrailers is to compare ABS maintenance costs per hundred miles. Figure 31 shows the costs, in dollars per hundred miles (CPCM) found in each of the two programs.[3]<sup>26</sup> These cost rates include all in-service repairs, inspections, and adjustments to the ABS over the evaluation periods of both programs. The total CPCM was \$0.032 for the LCV study and \$0.044 for the semitrailer study.

---

the failed wheel-speed sensor resulted from improper installation, this problem should be re-classified. However, because the wheel-speed sensor was replaced and discarded, the exact cause of the problem could not be confirmed, and it remains in this classification.

<sup>26</sup> The results from the semitrailer study are taken from figure 3.5. "Distribution of ABS In-Service Wear Related Maintenance Costs on a Cents-per-Mile of travel basis Over the Two-Year Test Period by System Component Needing Work", page 3-16.

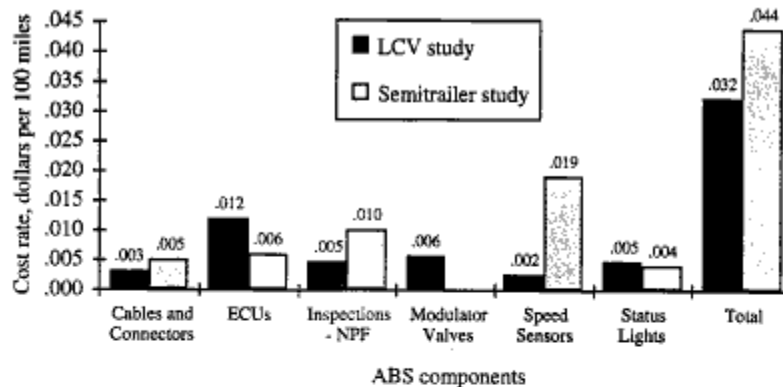

**Figure 31. Summary of maintenance cost rates for ABS components from the LCV study and the previous semitrailer study**

The largest difference in cost rate between the two studies is for wheel-speed sensors. In this classification, the rate is \$0.019 per 100 hundred for the previous study but only \$0.002 per 100 miles for this study. The difference is almost completely due to the larger number of adjustments of wheel-speed sensors required during the previous study. These adjustments are required when the gap between the wheel-speed sensor and the exciter ring exceeds the acceptable tolerance. This can be caused by external factors like road debris, accidental jarring during wheel maintenance service, or through improper wheel bearing adjustment and the resulting runout of the exciter ring. One possible explanation for the reduction of wheel-speed sensor problems in this study is that seventy-four of the units (65 percent) had new friction material and bearings installed during the retrofitting of ABS at the outset of the program. This would reduce the incidence of service requiring wheel and bearing adjustments and thus lessen the possibility of accidental displacement of the wheel-speed sensors.

The average number of miles between component repairs or adjustments is presented in figure 32 for both the LCV field study units and the semitrailers of the previous program.[3]<sup>27</sup> These numbers are based on 6.7 million miles of travel for the 114 LCV units of this study and 4.0 million miles for the fifty units of the semitrailer study. In both studies, inspections resulting in no repairs or adjustments were the most frequent cause of maintenance-related service. These data indicate that a typical non power unit will have a false problem report about every 350,000 miles. Problems associated with status lights will occur, on average, every 710,000 miles. Problems with cables and connectors and with

<sup>27</sup> Figure 3.6 "Miles Traveled Between ABS In-Service Wear Related Maintenance Incidents Over the Two-Year Test Period by System Component Needing Work", page 3-17.

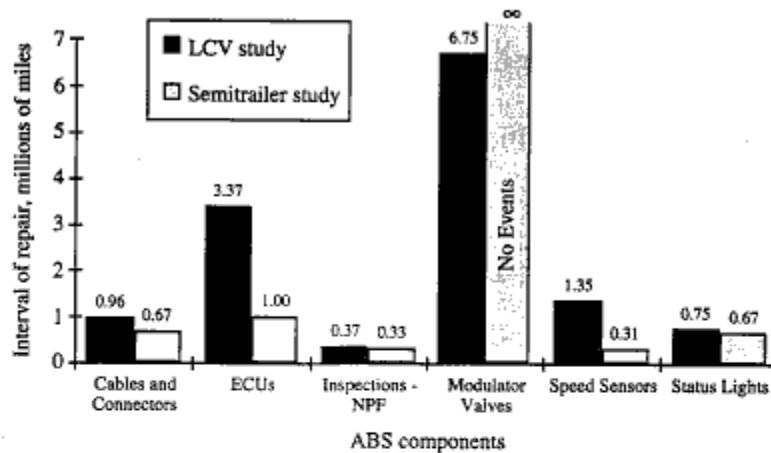

Figure 32. Summary of ABS component repair rates from the LCV study and the previous semitrailer study

wheel-speed sensors will occur, on average, every 820,000 miles. The ECU will require service about every 2.1 million miles. Finally, only one modulator valve problem occurred in the LCV field study while none occurred in the semitrailer study. Based on the miles accumulated by the LCV units, a problem of this type would occur every 6.7 million miles on a typical non power unit. However, it should be noted that this problem was related to the use of in-line antifreeze which is discouraged by ABS suppliers.

Figure 33 presents yearly rates of maintenance of ABS components as projected for a hypothetical fleet of 100 semitrailers. Projections are presented based on data from the LCV study and the semitrailer study. These data include average yearly mileages per unit of 40,100 from this study and 42,000 from the semitrailer study. These projections include occurrences of adjustments and inspections as well as repairs or replacements.<sup>28</sup> Using the average of the rates shown in the figure, a typical fleet with 100 non-power units would experience 11.6 false inspections; 8.3 wheel-speed sensors; 5.8 status lights; 5.2 cables and connectors; and 2.7 ECU maintenance incidents per year.

<sup>28</sup> In the semitrailer study, repair rates given for the various ABS components were based only on repair/replacement incidents and excluded adjustments or inspections. For this program, however, incidents of adjustments or inspections were included. Moreover, the results of the semitrailer study have been re analyzed to include adjustments or inspections. Upon review of all of the maintenance records collected in this study (including the historical records), it appears that all five of the participating fleets did track and assign all maintenance activity to specific units. Review of the records showed that of the 1,472 trailer records collected from the five fleets, 485, or 33 percent, were for inspections or adjustments. For this reason, the frequency of maintenance events shown in figure 33 includes all costs associated with the system, not just the ones that involved repair or replacement of a component.



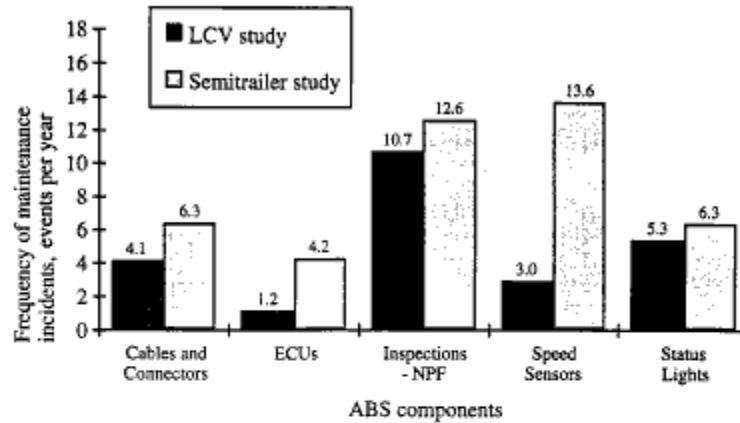

Figure 33. Frequency of maintenance incidents of ABS components for a hypothetical fleet of 100 trailers and dollies

#### Maintenance Of ABS On Tractors

Fourteen in-service ABS problems were reported for all seventeen tractors during the field study. These fourteen problems were concentrated in six of the units (35 percent). The fourteen problems resulted in a total maintenance cost of \$1,126.25. Overall, the cost per unit for ABS maintenance was \$66.25. Given that these units traveled 3.76 million miles during the study, the maintenance cost per 100 miles was \$0.030. The cost per unit and cost rate from this study compare favorably with those of the earlier study conducted by the NHTSA.[2] In that study, 200 tractors were found to have average ABS maintenance costs of \$90.79 per tractor and ABS maintenance cost rates of \$0.046 per 100 miles.

Seven of the fourteen ABS problems occurred on one tractor. This unit seemed to have intermittent problems that caused the status light to indicate the system needed service. Four of the problems were resolved by replacing wheel-speed sensors or adjusting the wheel bearings. The other three reports were investigated but resulted in no problems being found. Two of these reports were filed late in the study by experienced drivers. The system was thoroughly checked at the end of the study by a Rockwell WABCO representative. During the investigation the representative found that a wheel-speed sensor wire had been repaired in a manner not recommended by Rockwell WABCO. This may have caused the intermittent faults.

Table 13 summarizes the distribution of these maintenance events and costs according to the element of ABS at fault. A discussion of each class of problems follows.

**Table 13. Summary of ABS maintenance costs for seventeen tractors**

<i>Component</i>	<i>No. of Problems</i>	<i>Labor Time (hrs)</i>	<i>Labor Costs (\$)</i>	<i>Parts Costs (\$)</i>	<i>Total Cost (\$)</i>	<i>Cost per Unit (\$)</i>	<i>Cost/100 Miles (\$)</i>
<i>Cables/Connectors</i>	3	9.0	315.00	40.0	355.00	20.88	0.009
<i>ECU</i>	0	0.0	0.00	0.0	0.00	0.00	0.000
<i>Inspection - NPF</i>	6	3.0	105.00	0.0	105.00	6.18	0.003
<i>Modulator Valves</i>	0	0.0	0.00	0.0	0.00	0.00	0.000
<i>Speed Sensors</i>	4	12.8	446.25	120.0	566.25	33.31	0.015
<i>Status light</i>	1	2.0	70.00	30.0	100.00	5.88	0.003
<i>Total</i>	14	26.8	936.25	190.00	1126.25	66.25	0.030

*Cable and connectors*

The three cable and connector problems occurred on three different units in three different fleets. Two were ultimately resolved when loose cables were located and reconnected. One of these was the result of a loose wheel-speed sensor cable and took 1.5 labor hours to find and correct. The second was an intermittent problem and occurred on rough roads only. This problem also took 1.5 labor hours to correct. The third cable and connector problem was a result of damage to the cable of a wheel-speed sensor. Repair required the removal of a drive wheel in order to replace the wheel-speed sensor and cable. This repair required 6.0 labor hours and a wheel-speed sensor costing \$40.00.

In total, the three cable and connector problems required 9.0 hours of labor and \$40.00 in parts. The total cost was estimated at \$355.00 or \$20.88 per tractor. The CPCM for this class of repair was \$0.009.

*Inspection - No problem found*

There were six reports of ABS problems for which no malfunction could be detected and no repair was necessary. These problems did require effort on the part of maintenance personnel and an average inspection time of 0.5 labor hours was specified for this type of problem. Three of these problems occurred on one tractor that continued to have intermittent wheel-speed sensor problems throughout the study. Two of the problems occurred very early in the study and were attributed to driver inexperience. In one case, the driver was confused by differences in the operation of the status-light function on tractor and trailer systems. The other report indicated that, when applying brakes hard, some of the drive tires would lock-up and slide. Since this system involved a tandem-axle unit with a two-sensor system, we speculate that the non-sensed axle may have experienced the lock-up. The last problem was reported late in the program by an experienced driver. However, no problem could be identified on subsequent trips or upon completion of the study. The

total cost of these problems was \$105.00 or \$6.18 per tractor. These problems had a CPCM of \$0.003.

*Wheel-speed sensors*

There were four problems with wheel-speed sensors during the study. Three of the four problems involved one tractor. In two cases, the wheel-speed sensor on the left drive wheel was replaced.<sup>29</sup> The third problem was caused by excessive wheel bearing lash that led to a bad signal from the wheel-speed sensor. The fourth problem was originally identified as a dirty wheel-speed sensor. However, during later trips the problem reappeared. After further investigation, the wheel-speed sensor was replaced and the alignment of the exciter ring corrected. The total cost of these problems was \$566.25 or \$33.31 per tractor. These problems had a CPCM of \$0.015, which was the highest rate of expense for any ABS component on tractors.

*Status light*

There was one problem involving the function of the status light. The source of the problem was identified as a circuit breaker failure. The breaker was replaced at a total cost of \$100.00, or \$5.88 per tractor. This problem had a CPCM of \$0.003.

---

<sup>29</sup> As discussed above, when the system on this tractor was thoroughly checked at the end of the study, it was found that a wheel-speed-sensor wire had been connected to an extension cable using shrink tubing over the connection. This is not recommended practice for this ABS component.

### THE OPINIONS OF FLEET PERSONNEL REGARDING ANTILOCK BRAKING SYSTEMS IN LCV OPERATIONS

The drivers, mechanics, and fleet managers participating in the LCV field study were surveyed to determine their opinions on ABS. Five surveys were conducted periodically throughout the field study so that changes in opinion with exposure to ABS could be observed. The opinions of fleet personnel regarding the use of ABS on LCVs were found to be strongly positive. This was true with respect to ABS on tractors, trailers, and dollies. Opinions on ABS were positive at the outset of the study and tended to rise with exposure to ABS during the study. By the end of the study, drivers, on average, felt that ABS had helped them avoid or reduce the severity of an accident "a few times."

The survey included prepared questions dealing with reliability, maintainability, and general usefulness of ABS. Participants responded to these questions according to a prepared rating scale. They were also encouraged to provide written comments and observations about their experience with, and views on, ABS. Survey forms, along with an extensive presentation of survey results are presented in appendix C.

The prepared questions on ABS, and the language of the respective response scales, were as follows:

- *How familiar are you with antilock braking systems?* Not familiar; somewhat familiar; very familiar.
- *How would you rate the reliability of ABS?* Not reliable; average reliability; very reliable.
- *How difficult is ABS to maintain?*<sup>30</sup> Not difficult; average; very difficult.
- *What is your opinion regarding ABS on tractors?* Strongly favor; no opinion; strongly opposed.
- *What is your opinion regarding ABS on trailers?* Strongly favor; no opinion; strongly opposed.
- *What is your opinion regarding ABS on dollies?* Strongly favor; no opinion; strongly opposed.
- *Have you ever been in an emergency situation where ABS helped you avoid or reduce the severity of an accident?*<sup>31</sup> Many times; a few times; never.
- *Do you feel the use of ABS on the entire vehicle will change your job?*<sup>32</sup> Make it easier; no change; make it harder.

<sup>30</sup> Only managers and mechanics were asked this question.

<sup>31</sup> Only drivers were asked this question.

<sup>32</sup> Only drivers were asked this question.

An average of thirty-two drivers, fourteen managers, and twenty-one mechanics responded to each of the five surveys. One hundred ninety-one drivers participated in the study, but many of these only took one or two trips with the field study vehicles. Only those drivers who used the equipment regularly were asked to complete questionnaires.

The summary results for each of these questions are presented in figure 34. Pooled results are presented for drivers, mechanics, and managers, respectively. The vertical scale of the graph is arranged such that positive reactions to ABS are up and negative reactions are down. Results are presented for each of the five surveys, with time progressing from left to right.

There were forty-three positive and two negative comments on ABS written in on the survey forms. All written comments appear in appendix C.

A discussion of results for each individual question follows. A sample of written comments related to the question is presented where available. Comments are identified with the personnel group and the data source (i.e., the number of the survey or the abbreviation DTF, for driver trip form), for example, [Driver, 3].

#### **Familiarity: How familiar are you with Antilock Braking Systems?**

As expected, all the fleet personnel showed a trend toward becoming more familiar with ABS as the study progressed. Surprisingly, all three groups felt they were *somewhat familiar* with ABS at the start of the study. Drivers had the largest change from less than *somewhat familiar* to nearly *very familiar*, an increase of about 50 percent. Most importantly, however, all three groups, on average, felt they had an increased knowledge of ABS as a result of the study.

#### **Reliability: How would you rate the reliability of ABS?**

Over the course of the study, all three groups showed an increase in their evaluation of the reliability of ABS. Initially, the drivers and mechanics gave ABS an average reliability rating, while the managers were a little more confident in the systems. At the study's conclusion, drivers and managers felt most confident while the mechanics felt the system was not quite as reliable but still better than average.

#### *Written comments*

- From what I've seen the brakes (ABS) work well and seem to be reliable. [Mechanic, 2]
- The ABS are a great advantage. I haven't heard any complaints by the drivers and I haven't noticed much mechanically wrong with the system. [Mechanic, 2]
- The ABS system seems to work very good in the few times I have had to really use it. [Driver, 3]
- This stuff is still working great. Everybody should be using it. [Mechanic, 3]

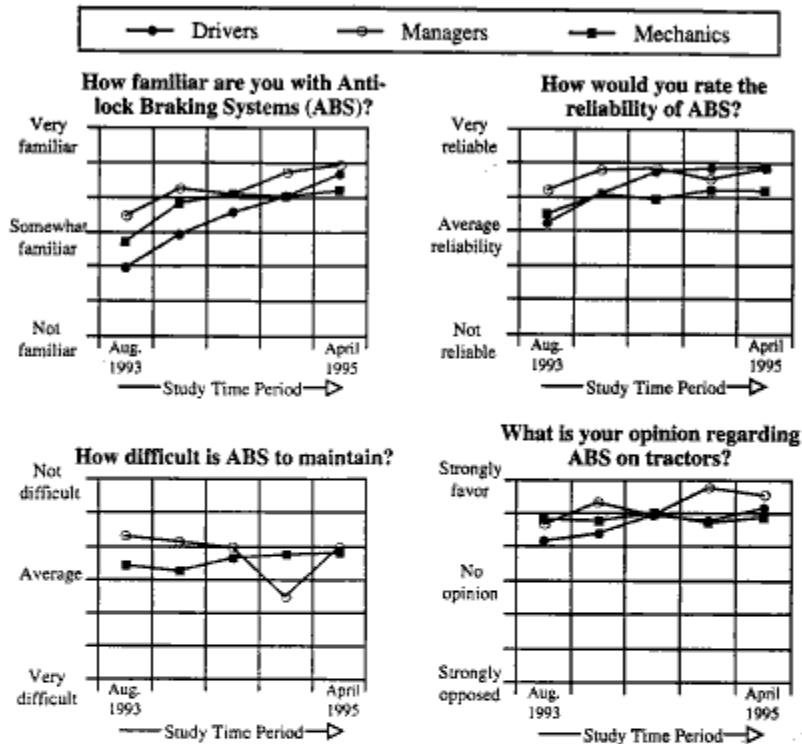

Figure 34. Opinions of fleet personnel on ABS in LCV operations

- Equipment wise, from a mechanical view, ABS has proven to be very effective and reliable. Very few problems were encountered. From an operational view, ABS & C-dollies require more education & training. Operators accept them for the most part, but as with anything new there is always some resistance. I personally liked all the equipment involved and felt after a delayed start-up period, I think our part of the test went really well! [Mechanic, 5]
- The test equipment was very reliable. [Mechanic, 5]
- ECU Box needs to be placed [away from in] front of tires, too much water & spray shorts out [on trailers]. [Mechanic, 5]

**Maintenance And Use: How difficult are ABS to maintain?**

Only the managers and mechanics were asked to evaluate how difficult ABS are to maintain. Throughout the study, the mechanics rated ABS as a little easier than *average* to

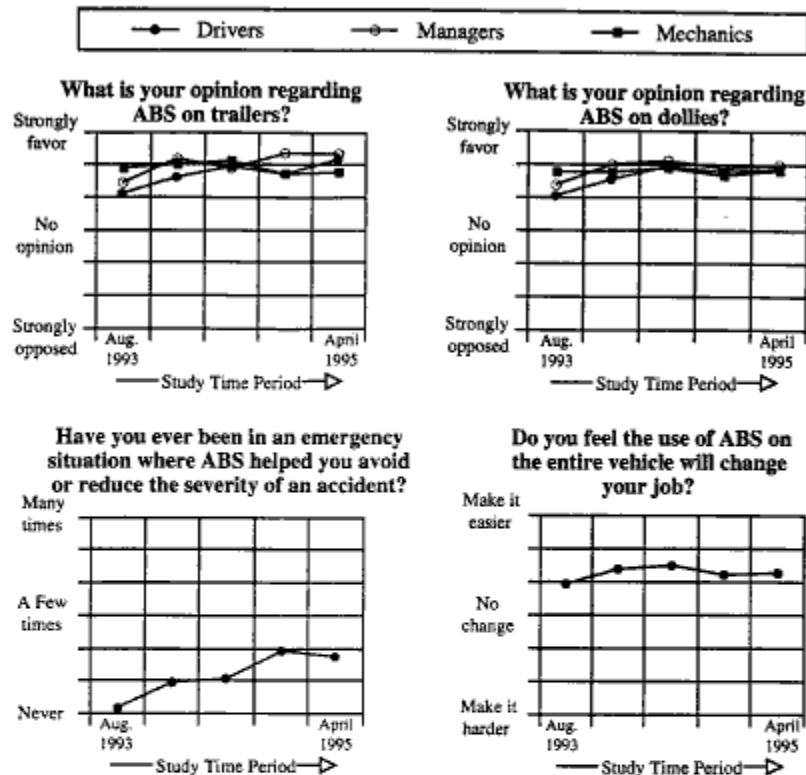

Figure 34 [continued]. Opinions of fleet personnel on ABS in LCV operations

maintain and showed a slight improvement in this rating over the course of the program. This is encouraging because the general attitude seems to be that any electrical system on heavy-duty units is more difficult to understand, diagnose, and fix than a mechanical system. However, this attitude is probably changing due to the increased use of electronics in the heavy-tractor business. Additionally, the ABS suppliers gave the fleets repair manuals and all ECUs had built-in diagnostics to help identify and repair problems.

Managers were initially more optimistic than mechanics about maintaining ABS, but by the end of the study their assessment of the ease of maintaining ABS had declined and was very close to that of the mechanics. This was the only case in which the trend of the results did not increase during the study. There was a surprising dip in the managers' response during the fourth survey period. This may be explained by the small number of responses

for this question in that survey. Typically, there were twelve to fourteen responses for every question. However, only eight were received for this question in the fourth survey.

*Written comments*

- It appears that ABS is NO more difficult to maintain than non-ABS equipment. [Manager, 5]
- We have not seen many problems with the ABS. [Mechanic, 2]
- I don't think we encountered any more problems with the test equipment than other equipment in the fleet. [Mechanic, 5]
- Rockwell ABS is real simple to install and maintain, as well as finding fault codes. [Mechanic, 2]
- We do not see enough of the equipment now because of no problems, so the ABS must be doing a real good job. [Mechanic, 3]

**ABS Use: What is your opinion regarding ABS on tractors, trailers, and dollies?**

When asked for opinions regarding ABS on tractors and trailers, all three groups started with a moderately favorable position and moved toward a *strongly favorable* opinion. On average, the results were virtually identical for all three types of units. Managers had the highest opinion of ABS on all three units toward the end of the study.

A manager at one fleet did question the necessity of ABS on C-dollies. His concern was that the primary goal of ABS is to maintain directional stability during braking and, since C-dollies can not steer relative to the lead trailer, ABS on the dolly may not be as necessary, particularly if the lead trailer has ABS. However, if tire flat-spotting is the concern, then ABS is as appropriate on C-dollies as on any other unit.

*Written Comments*

- The ABS delivers maximum braking ability to double and triple operation with obvious safety consequences. [Driver, 3]
- Braking and stability of doubles and triples combinations are greatly improved with ABS. [Manager, 2]
- From what I have seen, I am impressed with both (ABS and C-dollies). [Mechanic]
- As a mechanic and shop foreman, I am impressed with the operation of both ABS and the C-dolly. [Mechanic, 5]
- I feel that ABS is a plus to all fleets operating LCVs. [Mechanic, 2]
- I believe the ABS brakes, when used on tractors, trailers, and dolly together as a unit, gives the driver a much greater braking ability in a much shorter distance. [Driver, 2]
- The only reason I feel the ABS is more work at this time is the extra we are doing for this test. [Driver, 2]



- ABS brakes are the way to go. [Driver, 2]
- ABS is probably the coming thing in transportation. More testing should be done in winter driving. [Driver, 3]
- If I had my choice, I would want ABS on all vehicles. [Driver, 5]

**Frequency Of ABS Activity: Have you ever been in an emergency situation where ABS helped you avoid or reduce the severity of an accident?**

To obtain a sense of the frequency of substantial ABS activity, the drivers were asked to judge how often ABS helped them to avoid or reduce the severity of an accident. The results from the first survey showed drivers did not feel that ABS had helped them in such a situation. Over the course of the study, however, the average response to the question rose to indicate these drivers felt ABS had been significant to them a few times. This result is interesting because it shows that drivers do believe they periodically encounter situations where ABS play a role in the stability of the vehicle.

This trend toward crediting ABS in emergency situations was supported by a total of sixty-three reports of substantial braking event by the drivers during the study. Given that 1.4 million trip miles were logged during this period, one significant braking event was reported for every 22,400 miles traveled.

*Written comments*

- A wide load (1/2 house) drove into the path of my truck with traffic in the left lane that wouldn't move, so I had to make a sudden stop - from 55 mph to 10 mph. [Driver, DTF]
- Heavy braking to avoid three deer - unsuccessfully! [Driver, DTF]
- Had to change lanes and get on the brakes hard to avoid a slow car. I was very impressed with the ABS system; it works like a dream. Conditions: Time - 11:00 am, Climate - clear, Road - dry, Load - mixed. [Driver, DTF]
- Six head of deer ran out into roadway. I had to come to a complete stop in order to miss all of the deer. I don't think that I could have stopped in time or without skidding tires or jackknifing with regular brakes. Conditions: Time - 10:30 am, Weather - clear, Road Condition - dry, Load Condition - full. [Driver, DTF]
- Coming down Winchester grade, I came around a curve and a rock slide came across two lanes. I got on the brakes hard and went to the right into a wide spot along the road. I had no problems with any sliding or locking up. Tractor, dolly and trailers handled good! Conditions: Time - 1:40 pm, Climate - rain, snow/ice and windy, Road - wet, Load - full. [Driver, DTF]
- Braking incident - a vehicle spun out sideways in front of me and I had to come to a very sudden stop to avoid (it). Everything stayed in line and seemed to handle well. Conditions: Time - 2:10 am, Climate - snow/ice, Road - ice, Load - full (68500 GCW). [Driver, DTF]

- Following about 100 ft. behind a four wheeler on Hwy. 395 at milepost 67 in a [severe] dust storm when I saw brake lights and then was able to see traffic at a stop in front of us. The four wheeler locked up his brakes and steered off the roadway to avoid stopped vehicles. Est. speed at time of emergency was 40-50 mph. Even though trailers were virtually empty, everything came to a smooth, straight stop with about 80 ft. to spare. [Driver, DTF]
- Sudden Braking - Trucks in middle of road on hill and curve. Road surface was solid ice. I was able to stop and pull off out of the way with very little trouble. Conditions: 12:30 AM, Climate - freezing rain, Road -ice, Load - full. [Driver, DTF]

**Effect Of ABS On The Driver's Job: Do you feel the use of ABS on the entire vehicle will change your job?**

To determine whether drivers view ABS as an aid or a burden, they were asked to rate the overall influence of ABS on their job. The drivers consistently indicated that, overall, ABS did change their job toward *making it easier*.

*Written comments*

- I like having ABS. It makes my job safer and the safer it is, the more I like it. [Driver, 4]
- I have never been in a "near" accident with ABS and yet I feel much more comfortable pulling equipment with ABS systems -- especially when "bob-tail" or pulling empty trailers. [Driver, 2]
- It was a joy to drive the all ABS systems between Portland and Boise—the "C" dollies were terrific and the ABS brakes were a nice change from individual axles "locking-up" in demand situations. [Driver, 3]
- Use of a bobtail tractor with ABS is much more easily maneuverable when in a braking situation. I appreciate the use of ABS equipment I've had the opportunity to use as a driver here at [fleet name]. [Driver, 4]
- I always feel confident I'll be able to control my equipment even under extreme conditions when my truck and trailers are equipped with an ABS equipped C-dolly. C-dollies equipped with ABS keep your trailers in a straight line on slick surfaces even under hard braking situations. [Driver, 3]
- I do like ABS brakes on all wheels. It greatly reduces the stopping distance. I have nothing but good things to say about ABS. [Driver, 4]
- ABS brake system are 100 percent more efficient than standard air brake systems. Smoother—more responsive and better combined braking over all. [Driver, 3]

### SUMMARY OF OPINIONS ON ABS

In general, the response of the personnel of the participating fleets to ABS was very positive. Table 14 shows a summary of the opinion results for each question. The table shows the percentage of each group (drivers, mechanics, and managers) who rated the ABS positively in response to the individual questions.<sup>33</sup> All of the categories except one show a strong bias toward a positive response. In fourteen of the twenty-four categories, over 90 percent of those surveyed answered positively.

**Table 14. Positive ratings of ABS by fleet personnel**

Survey questions	Percent positive responses		
	Drivers	Mgt.	Mech.
<i>How familiar are you with Antilock Braking Systems?</i> Not familiar; somewhat familiar; very familiar.	71	96	83
<i>How would you rate the reliability of ABS?</i> Not reliable; average reliability; very reliable.	92	96	92
<i>How difficult is ABS to maintain?</i> Not difficult; average; very difficult.	N/A	71	79
<i>What is your opinion regarding ABS on tractors?</i> Strongly favor; no opinion; Strongly opposed.	100	100	100
<i>What is your opinion regarding ABS on trailers?</i> Strongly favor; no opinion; Strongly opposed.	100	100	100
<i>What is your opinion regarding ABS on dollies?</i> Strongly favor; no opinion; Strongly opposed.	100	100	96
<i>Have you ever been in an emergency situation where ABS helped you avoid or reduce the severity of an accident?</i> Many times; a few times; never.	4	N/A	N/A
<i>Do you feel the use of ABS on the entire vehicle will change your job?</i> Make it easier; no change; make it harder.	92	N/A	N/A

<sup>33</sup> A positive response is a response above 4 on the 7-point rating scale used for each question. This scale is represented by the seven lines of the verticle grid of figure 34.

## **C-DOLLIES AND THE DYNAMIC STABILITY OF LONG COMBINATION VEHICLES**

The findings of this field study confirm the findings of many previous research efforts in regards to the lateral performance qualities of LCVs. That is, this study found that C-dollies serve to improve the dynamic stability of double- and triple-trailer vehicles by reducing the rearward amplification response which is evident in these vehicles when they are equipped with A-dollies. The lateral acceleration performance of the roughly one hundred tractors and trailers of the field study fleet showed the same tendencies with respect to rearward amplification as have previously been measured and explained through test-track experiments and analyses. When operating with A-dollies, the trailers of the LCV study vehicles tended to experience substantially larger lateral accelerations than the tractors towing them (i.e., rearward amplification). When equipped with C-dollies, this tendency was greatly reduced or reversed. The sensitivities of the rearward amplification response to such factors as trailer wheelbase, speed, and number of trailers was generally the same in the test fleet as found in previous work. C-dollies produced the greatest improvement in lateral behavior in those vehicles displaying the greatest rearward amplification when using A-dollies (i.e., triples).

Beyond the traditional measure of rearward amplification, the data gathered in this field study also provide other interesting insights into the lateral acceleration experience of multi-trailer commercial vehicles, and *perhaps* into the response of the drivers to the lateral performance characteristics of their vehicles.

## **INTRODUCTION TO REARWARD AMPLIFICATION AND THE STABILITY OF MULTITRAILER TRAINS**

C-dollies exist because of a desire to improve the dynamic maneuvering capability of commercial vehicles pulling multiple trailers. The emergency maneuvering capability of double- and triple-trailer vehicles equipped with the traditional A-dolly is reduced (relative to typical tractor-semitrailer vehicle) due to a phenomenon known as *rearward amplification*. The use of C-dollies improves the dynamic performance of these vehicles by reducing rearward amplification.

In normal highway driving, the maneuvering qualities of multiple-trailer vehicles are quite good. However, in situations where the driver must make a quick, evasive maneuver, the lateral motion of the tractor may be exaggerated by each successive trailer. The last trailer of the vehicle may experience a maneuver which is anywhere from twice to several times more severe than the maneuver initiated by the tractor. As a consequence, the rear trailer of such vehicles is more susceptible to rolling over in an evasive maneuver, and the



**Figure 35. The rear trailer of a western double approaching rollover in a rapid lane change maneuver**

safe maneuvering ability of the overall vehicle is reduced. The phenomenon is illustrated in figure 35 in which the tractor and first trailer have successfully completed a rapid lane change that would result in rollover of the second trailer.

Rearward amplification has been studied in much detail by a number of researchers (e.g., [14-23]). The work to date has been both analytical (including extensive vehicle simulation work) and experimental. Test track work has generally confirmed analyses leading to a general acceptance within the technical community that the phenomenon is well understood.

In formal definitions, rearward amplification is expressed as the ratio of the lateral acceleration experienced by the last trailer to that of the tractor.[24,25] One such definition is illustrated in figure 36.

Rearward amplification is strongly influenced by the frequency content (quickness) of the maneuver. Thus, methods for measuring rearward amplification always account for the *frequency content* of the maneuver. The frequency of the maneuver represented in figure 36 is characterized by the time required for the tractor to complete the lane change. To fully characterize rearward amplification by this method, a number of tests would be undertaken in which the time period of the tractor maneuver would be varied—typically from a low of two seconds up to four or more seconds. (Expressed in *frequency*, this is the same as 0.5 to 0.25 cycles per second, or *hertz* (hz).) A different rearward amplification would be measured for each maneuver frequency.

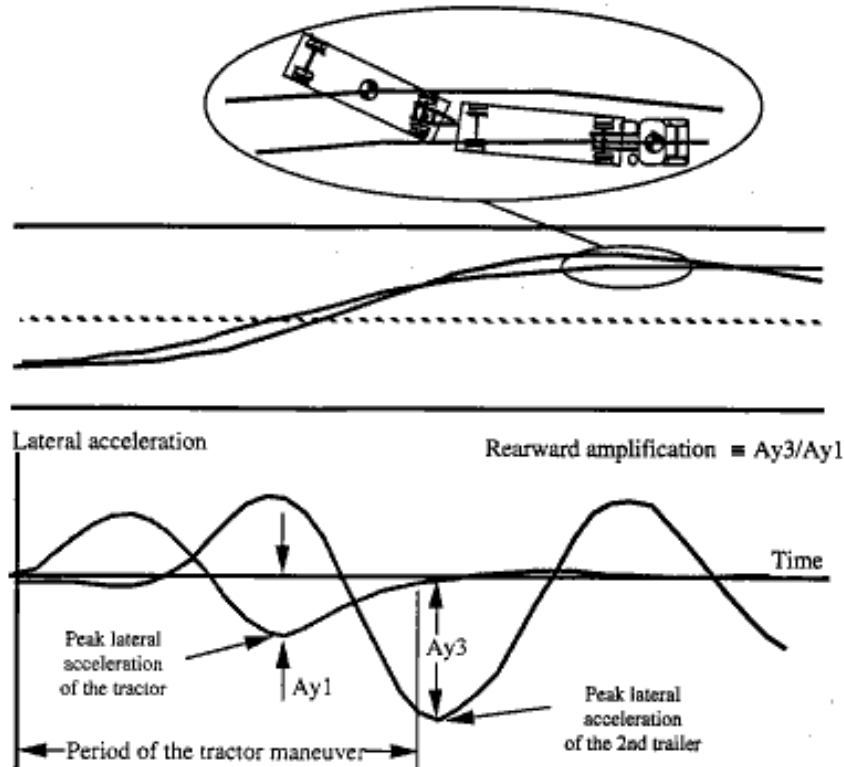
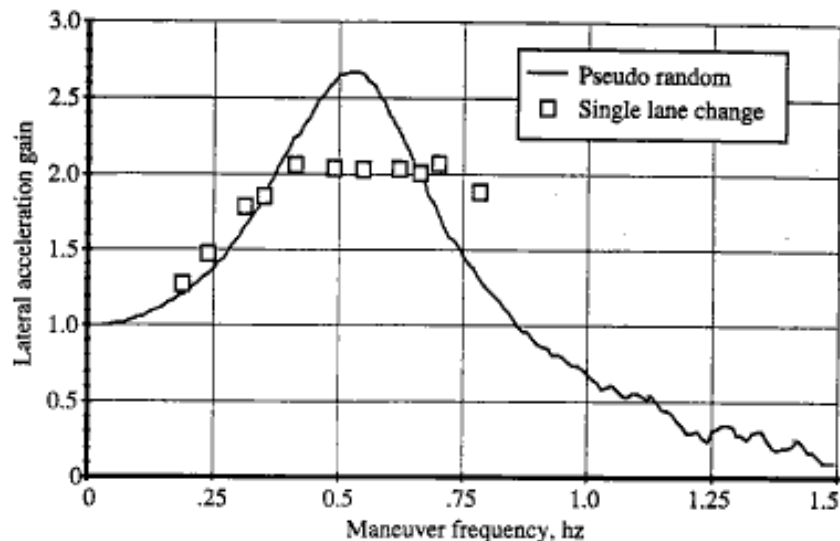

**Figure 36. Rearward amplification is defined as the ratio of the trailer lateral acceleration to tractor lateral acceleration and is sensitive to the period (or frequency) of the tractor maneuver**

Another means for measuring rearward amplification on the test track involves pseudo-random steering. The method is more scientifically attractive than the lane change method since it yields a more complete and generally applicable measure, but it does not have the intuitive appeal of a "real-world" maneuver. In this method, the driver introduces pseudo-random steering. There is no intent to follow a path; rather, the intent is to introduce steering over the full frequency range (slow to quick). The resulting motion of the trailers is compared with the motion of the tractor through *frequency domain analysis* techniques by which the rearward amplification of the vehicle can be determined at all frequencies at which the driver provided significant input power.

Results from both lane-change and pseudo-random-steering methods for measuring the rearward amplification appear in figure 37. The plot shows measured rearward amplification (on the vertical axis) as a function of maneuver frequency (on the horizontal





**Figure 37. Rearward amplification of a loaded western double from simulations of the lane-change and pseudo-random test methods (55 mph)**

axis). Rearward amplification is expressed in terms of lateral acceleration gain, that is, the ratio of trailer lateral acceleration to tractor lateral acceleration as a function of frequency. Maneuver frequency is in hertz. The graph illustrates how strongly rearward amplification is a function of maneuver frequency. At very slow frequencies (toward the left) rearward amplification is nearly one, which means that the trailers would travel nearly the same path as the tractor. This is the frequency range in which regular maneuvering (like normal lane changes and long steady turns on exit ramps) takes place. At more elevated frequencies, rearward amplification grows to about two or more. Maneuvers in this frequency range (characteristic of emergency maneuvers) result in the trailer experiencing a maneuver at least twice as severe as the tractor. At extremely high frequencies, rearward amplification falls off again. In this range, the tractor maneuver is so quick that the trailer is not able to follow. Maneuver frequencies this high are generally faster than the driver is capable of inputting to the vehicle (although road roughness and other disturbances contribute input to the tractor at these frequencies).

The qualities that produce rearward amplification are always present in the vehicle, but dramatic trailer response is unusual because the driver rarely makes significant steering inputs in the sensitive frequency range. On the other hand, road roughness and other small disturbances such as wind gusts do introduce small motions of the tractor and lead trailers which are in the sensitive frequency range. These inputs, multiplied by the rearward amplification mechanism, produce the visible swaying of the rear trailer of doubles and

triples which is often apparent to other motorists. The existence of these motions is evidence that the rearward amplification mechanism is inherent in the vehicle.

### MEASUREMENT OF THE DYNAMIC STABILITY OF THE LCV FIELD STUDY FLEET

Each tractor and trailer of the field study fleet was equipped with an accelerometer to measure the lateral motion of the unit. (Although examining the influence of dolly design was the goal, the dollies themselves were not equipped with accelerometers. The influence of the dollies on the motion of the trailers is the point of interest.) The data signals from these accelerometers were monitored continuously while the vehicles were in use over about a ten-month period.<sup>34</sup> However, to make data storage manageable, these signals were partially processed on-line in the vehicle and were stored in reduced forms. Data describing the *frequency content*<sup>35</sup> of the lateral acceleration experience of the unit was stored in the on-board logger, as were histograms of the *magnitude* of lateral acceleration experience. These data were further identified according to the travel speed of the vehicle in ten-mph ranges (e.g., 35 to 45 mph, 45 to 55 mph, etc). Continuous recording of lateral acceleration took place only during unusual events. Continuous recording could be triggered by high values of lateral acceleration as well as high-level braking and substantial ABS activity. Vehicle instrumentation and data processing are described in far more detail in appendix B.

The results presented below derive from cumulations of data over many trips. That is, results are not presented for *one* vehicle or *one* trip, but rather for the average of all the data of all the trips of all the vehicles (in most cases, from several of the five participating commercial fleets) of a specific class.<sup>36</sup> Data classes may be defined by vehicle configuration, dolly type, loading, speed, etc.

#### Rearward Amplifications Of The LCV Field Study Fleet—Analyses In The Frequency Domain

Figure 38 provides one example of the rearward amplification behavior observed in the LCV study fleet. These results derive from data taken on loaded triples when these vehicles were traveling in the 55 to 65 mph range. Starting from the left, the figure presents separate plots for rearward amplification as a function of frequency, measured at the first, second,

<sup>34</sup> The first systematic operation of the electronic data gathering system began in May of 1994. The systems were in full operation in all fleets by the end of June, 1994, and use continued until the end of April, 1995.

<sup>35</sup> These data represented the *power spectral density* (PSD) of lateral acceleration experience within each velocity range. Lateral acceleration gain as a function of frequency (for a given velocity range) was obtained by manipulating trailer PSD and tractor PSD data along with a *coherence function* obtained in special tests of the study vehicles. See appendix B for details.

<sup>36</sup> By *all* trips, we mean all trips from which satisfactory data records were derived. See the discussion on the accumulations of mileages in the field study starting on page 21.



Puede ser consultado en:

<http://www.hti.umich.edu/cgi/t/text/text-idx?sid=50cf84488b83cc2b8ba0554be1cc5c98;c=umtri;idno=88519.0001.001>

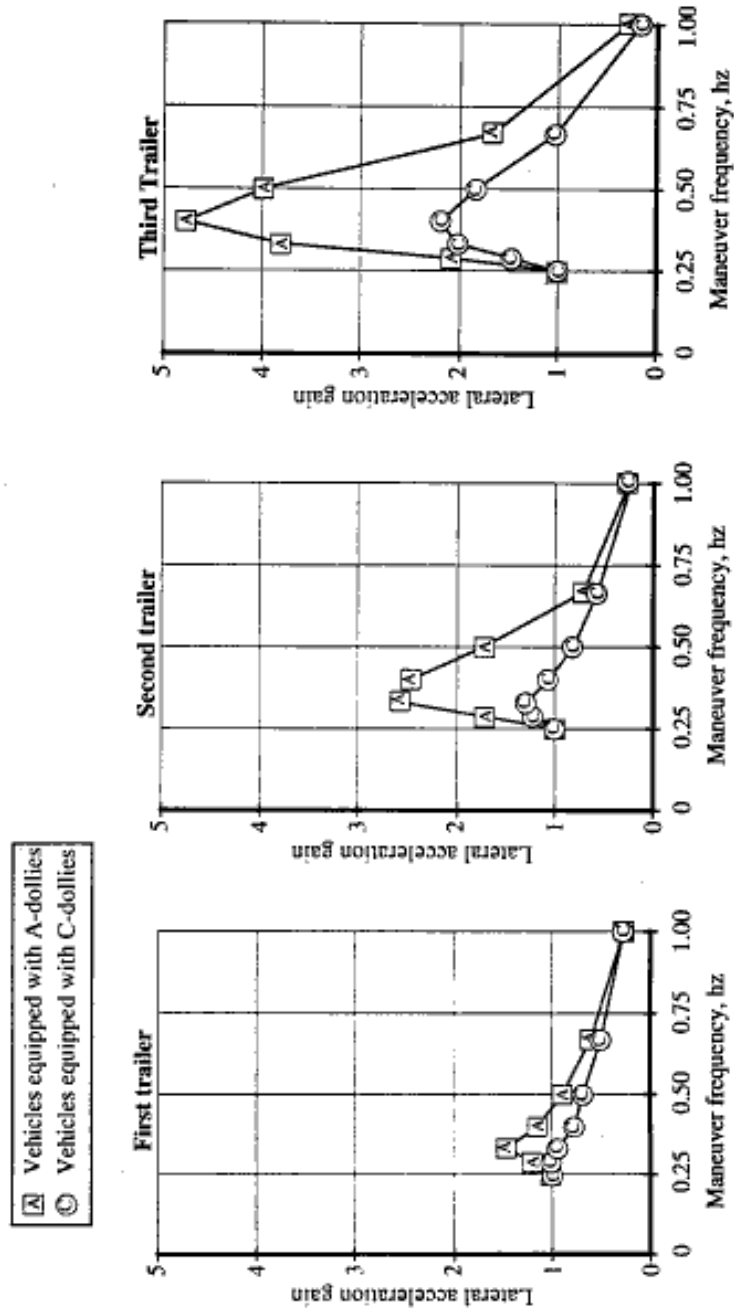

Figure 38. Comparison of the lateral acceleration gain (rearward amplification) measured on loaded triples of the LCV field study while equipped with A-dollies and with C-dollies (55-65 mph)

and third trailers, respectively. Each of these plots shows results obtained for the vehicles operating with A-dollies and C-dollies, respectively.

Figure 38 clearly reveals the relatively high levels of rearward amplification that were present in the second and third trailers when A-dollies were in use, and the very substantial reduction in rearward amplification that resulted from the use of C-dollies.

The data plots of figure 38 are of the form used in figure 37 to present rearward amplification measurements. That is, the vertical axis represents lateral acceleration gain—the ratio of trailer lateral acceleration to tractor lateral acceleration—and the horizontal axis represent maneuver frequency. The data plots cover a frequency range up to one hz. As noted earlier, frequencies input by the driver in normal driving lie roughly in the lower quarter of this range. Measurement of rearward amplification during the *normal* travel of this study, yet, covering this full frequency range, was possible because the small disturbances input to the tractor from road roughness and other external sources provide adequate input power in the higher frequency range. The fact that rearward amplification is readily apparent even in vehicle motions generated in this way is simply confirmation that this response property is inherent—and always present—in the vehicle.

Figure 38 displays rearward amplification properties which are remarkably similar to those obtained in traditional analyses and test track experiments: (1) Rearward amplification is a strong function of frequency, peaking in the range of 0.33–0.5 hz for these short-trailer vehicles. (2) Rearward amplification grows with each successive trailer, regardless of dolly type in use. (3) Peak amplification of the second trailer of the loaded, short-trailer A-train is in the range of 2 to 2.5 and nearly twice that (4.8 in this case) for the third trailer. (4) C-dollies substantially reduce rearward amplification; the rearward amplification of the *third* trailer of the C-trains is roughly equivalent (but somewhat lower in this case) to that of the *second* trailer of the A-trains.

An extensive presentation of results similar to those from which figure 38 derives, is presented in tabular form in appendix L. Results for triples, western doubles, Rockies, and reverse Rockies are given. Results are segregated for different loading conditions and speeds.

The detailed results of the appendix are summarized here in figures 39 and 40. Rather than presenting the full rearward amplification plots (as in figure 38), these two figures show only the *peak* values of amplification taken from those plots. Peak rearward amplification (on the vertical axis of figure 39) is then shown as a function of speed (on the horizontal axis) with the presentation distinguishing between vehicle configuration, dolly type, and loading condition.

Figure 39 gives the summary data presentation for western doubles and triples. The two graphs at the top of the page result from data collected with A-dollies in use and the

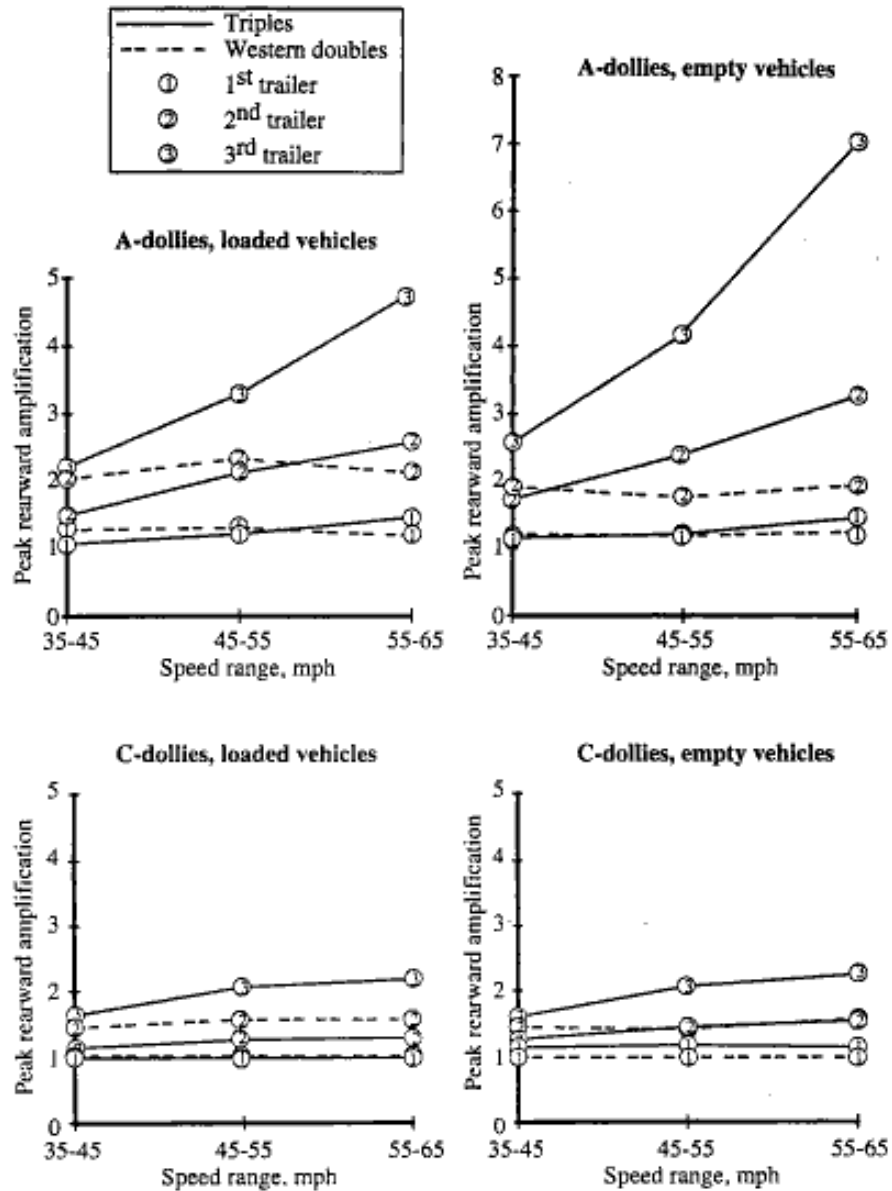

Figure 39. Peak rearward amplification of short-trailer doubles and triples as a function of loading, dolly type, and speed

two at the bottom are for C-dollies. The left hand graphs derive from loaded vehicles and the right hand graphs are for empty vehicles.

The results for the two types of vehicles that use short trailers exclusively (western doubles and triples) are superimposed in this figure because previous work suggests that the first and second trailers should behave similarly regardless of the presence or absence of the third. The data of the figure tend to support this with qualified success. Certainly the tendency for rearward amplification to increase with each successive trailer is shown to hold uniformly across all conditions represented in the figure.

The contrast between the upper and lower graphs in figure 39 clearly shows the advantage of the C-dolly over the A-dolly in all the applications of short-trailer combinations examined.

The data of figure 39, particularly the A-train data, also reflect the tendency for rearward amplification to increase with increasing vehicle speed. This is another property in which the field study data clearly agree with previous findings.[20] (This trend, of course, is the reason that results for travel below 35 mph are not presented.)

Finally, in contrast, the difference—or perhaps more accurately, the similarity—between the results for empty and loaded vehicles in figure 39 is not as might be expected based on previous work. In general, earlier findings suggest that rearward amplification should be somewhat more severe in loaded vehicles than in empty vehicles. While the difference is small, it would appear that the opposite is true in these data. We suspect this difference in results derives from the fact that traditional work concentrated on measurements made during moderate to severe maneuvers, while the vast majority of data leading to these results comes from the very minor “maneuvering” taking place hour after hour in ordinary, down-the-road travel. In this regime, there are many relatively minor mechanisms which may be more important than they are in severe maneuvers. For example, the relative importance of small amounts of play in the pintle hitches is surely more significant in minor maneuvering than in severe maneuvering.

Figure 40 presents results for Rocky Mountain doubles and reverse Rocky Mountain doubles in the same format used in figure 39. (There is no particular conceptual reason to superimpose the results for these two vehicles as there was for short-trailer doubles and triples. They are placed on the same graph simply to enhance comparison.) When using A-dollies, the trailers of these two vehicles tend to show similar or lesser rearward amplification than the first and second trailers of the short-trailer vehicles. Interestingly, the second trailer of the reverse Rocky displays markedly less rearward amplification than the second trailer of the standard Rocky, while the motions of the first trailer of the reverse vehicle are typically more amplified than those of the standard vehicle. These findings are compatible with previous work that indicates that longer trailer wheelbases result in reduced

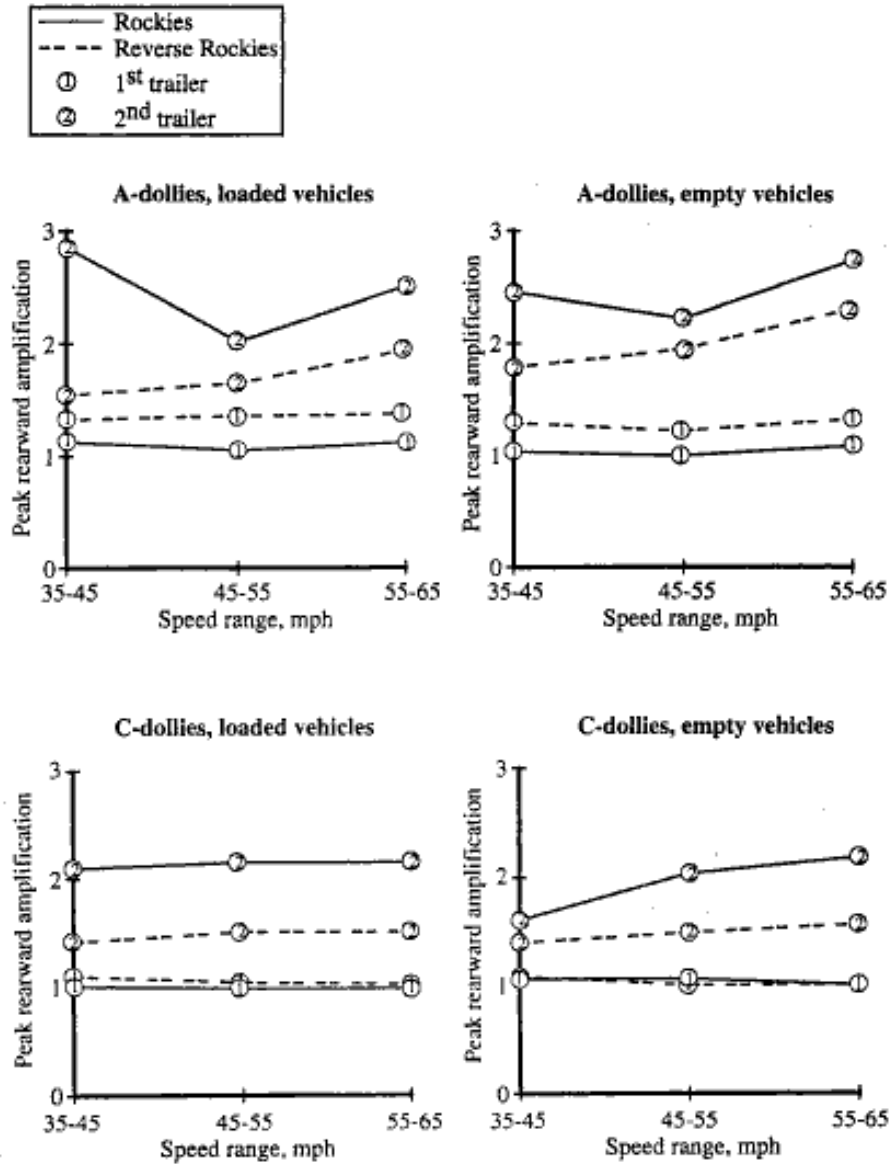

Figure 40. Peak rearward amplification of Rocky Mountain doubles as a function of loading, dolly type, and speed

rearward amplifications. Also, while the C-dolly improves the performance of these vehicles, the improvement is certainly not so striking as it is for the short-trailer vehicles.

Considering the immense differences between the methodology used in the LCV field study and the methodologies used in previous analytical and experimental investigations, the general agreement between the results shown in figures 38 and 39 and results reported in the literature is startling.<sup>37</sup> These new results would seem to lend further credence to existing findings, and vice versa.

#### **Rearward Amplifications Of The LCV Field Study Fleet—Implications Of The Lateral Acceleration Histograms**

Analyses of the lateral acceleration histogram data collected in the LCV field study fleet corroborate the observations made in the frequency domain. That is, that the rear trailers of multiple-trailer vehicles equipped with A-dollies tend to exaggerate the lateral motion of the tractor and that the use of C-dollies markedly reduces this response quality.

Figure 41 presents cumulative histograms of the lateral acceleration experience of all of the vehicles of the LCV field study in all travel above 45 mph. The upper graph results from data collected on vehicles equipped with A-dollies and the lower graph is for vehicles using C-dollies. Within each graph, results are shown separately for the tractor and the first, second, and third trailers.

The vertical dimension of these graphs represents the percentage of time traveled in which the vehicle experienced lateral acceleration (absolute values, of course) above the indicated value. The horizontal axis displays that indicated value of lateral acceleration expressed in gravitational units (g).<sup>38</sup>

The general shape of the curves is as one might expect. That is, the large majority of travel time is spent at very low lateral accelerations. At the tractor, only about 15 percent of travel time occurs above 0.03 g, and less than 1 percent of travel time is spent above 0.12 g.<sup>39</sup>

If the rearward amplification properties of vehicles influences these histograms, one would expect that influence to be manifest at higher accelerations. Accordingly, figure 42 is

---

<sup>37</sup> See appendix B for a discussion of the field test methodology and a comparison of a sample of these results with previous work.

<sup>38</sup> Lateral acceleration histogram data were collected in discrete bins all the way up to 0.47 g. Generally, however, the data above 0.22 g was so sparse as to produce very "noisy" results in the analyses which follow. Accordingly, the presentations of this section generally show cumulative histogram data up to 0.22 g. (Note that the higher data is not excluded, but is lumped as "above 0.22.")

<sup>39</sup> One percent should not be interpreted as an insignificant period of time. Consider the driver who covers 100,000 miles per year averaging 50 mph. That is 2000 hours per year, or the equivalent of a forty-hour per week job. At the 1 percent figure, this driver would spend twenty hours per year in this elevated range of lateral acceleration.

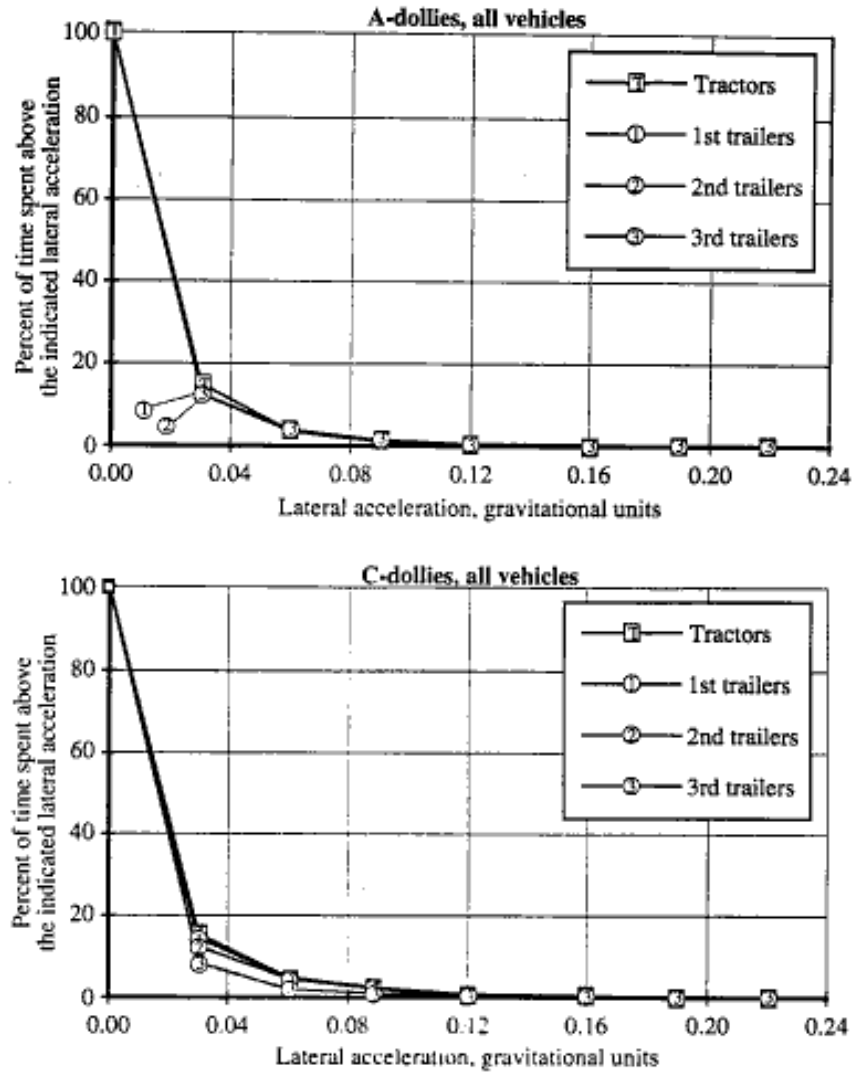
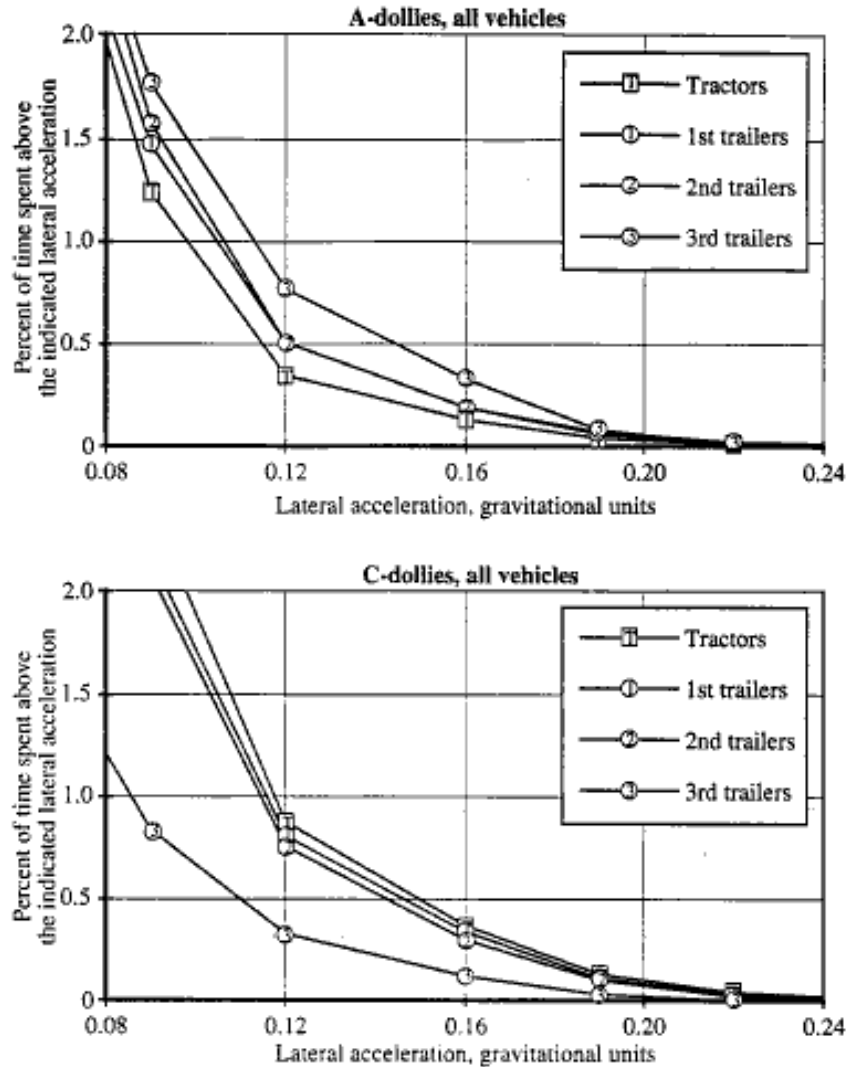

Figure 41. The lateral acceleration experience of all vehicles in the LCV study distinguished by dolly type (speeds above 45 mph)

a magnified view of the right-hand two-thirds of these histograms. In this figure, the influence of the rearward amplification mechanism becomes readily apparent in the relative experience of the tractors and the trailers which they tow.





**Figure 42. The lateral acceleration experience above 0.08 g of all vehicles in the LCV study distinguished by dolly type (speeds above 45 mph)**

Examining the upper graph, we note that when A-dollies are used, the trailers spend more time at elevated levels of lateral acceleration than do the tractors which pull them. Further, the trend is for each successive trailer to spend more time at higher accelerations than its predecessor.



Conversely, the lower graph shows just the opposite trend for vehicles equipped with C-dollies. In this case, each successive unit—tractor and trailers—tends to spend *less* time at elevated accelerations.

To present these data in a more readily interpretable format, we have created a rearward-amplification-like numeric which expresses *the lateral acceleration experience of trailers relative to the experience of the tractors*. This *relative experience* numeric is simply the percent-time figure for the trailers divided by the associated percent-time figure for the tractors.<sup>40</sup>

Figure 43 presents the *relative* lateral acceleration of the trailers which derives from the data of figure 41 (and 42). The plot makes the trends clear: the use of A-dollies tends to exaggerate the lateral acceleration experience of trailers while the use of C-dollies attenuates their lateral acceleration experience. Both trends appear stronger in the more rearward trailers and at more elevated levels of lateral acceleration.

Figure 43 presented data for *all* the vehicles of the field study fleet—Rockies, doubles, triples; loaded or empty. Figure 44 focuses on triples only and, further, segregates the loaded and empty vehicle data in the left-hand and right-hand graphs, respectively. The experience with A-dollies is shown in the upper graphs and the experience with C-dollies is shown in the lower graphs. The trends seen for the entire fleet (figure 43) are again seen here, but generally in more powerful and more orderly forms. (See footnote 40.) For example, the third trailer of loaded A-trains experience lateral accelerations above 0.22 g approximately *7.5 times more* than their tractors experience that level of lateral acceleration. But, third trailers of C-train triples experienced those same high levels of lateral acceleration *only 0.1 times* as often as their tractors.

The presentations of figure 43 and 44 (and the additional tabular data which appear in appendix L) corroborate the findings presented previously herein regarding measurement of rearward amplification in the study fleet. That is, the previous results show that the use of C-dollies tends to reduce the exaggerated motions of rear trailers as expressed in terms of rearward amplification, a measure in the frequency domain. The results of this section show that C-dollies also tend to reduce lateral motions of rearward trailers as observed in the time domain.

---

<sup>40</sup> Note that, in the development of the relative experience data presented herein, the division of trailer data by tractor data is done *after* the cumulation of data. This is in contrast to the method used to develop rearward amplification data in which the division in the frequency domain was done on a trip-by-trip basis and the results then cumulated. In retrospect, this latter approach would be more appropriate in both cases, and would lessen some of the erratic quality of these presentations. For example, the decline in the relative experience measure of the third trailers of A-trains shown at the higher accelerations of figure 43 is, in part, due to the fact that *third* trailer data is divided by *all* tractor data (including the tractors of doubles). This problem is attenuate when less inclusive data sets are analyzed, e.g. figure 44.

Puede ser consultado en:

<http://www.hti.umich.edu/cgi/t/text/text-idx?sid=50cf84488b83cc2b8ba0554be1cc5c98;c=umtri;idno=88519.0001.001>

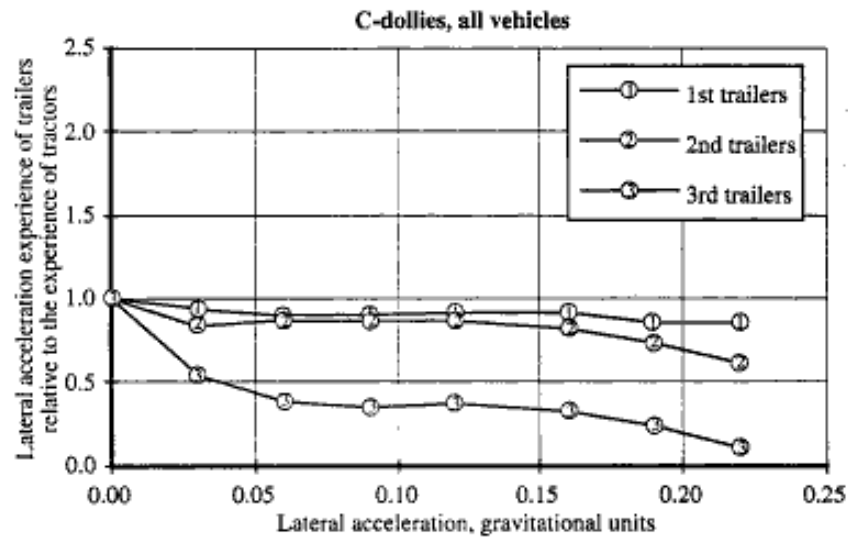
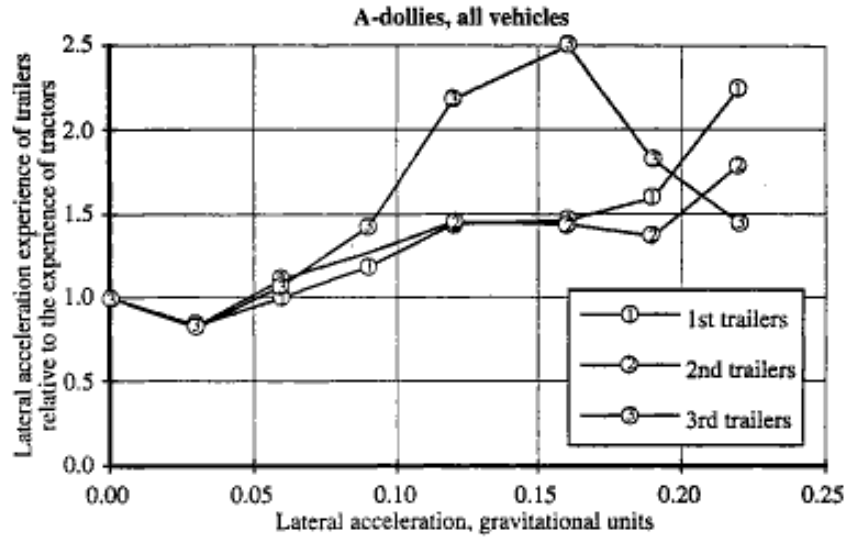

Figure 43. The lateral acceleration experience of all trailers relative to the lateral acceleration of tractors distinguished by trailer position and dolly type (speeds above 45 mph)

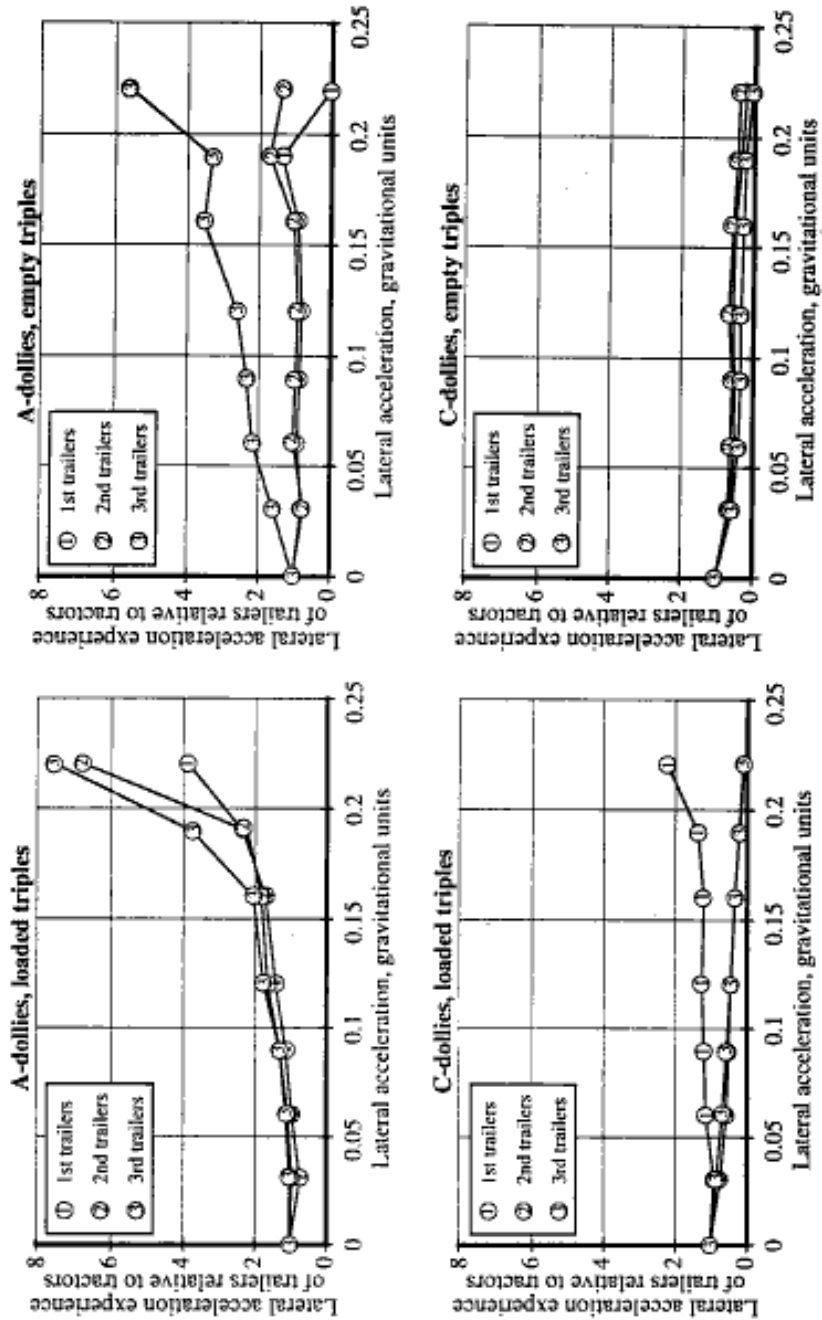

Figure 44. The lateral acceleration experience of the trailers of triples relative to the lateral acceleration of tractors, distinguished by dolly type, loading condition, and trailer position (speeds above 45 mph)

### QUALITIES OF TRACTOR LATERAL ACCELERATION HISTOGRAMS WHICH MAY REFLECT ON DRIVER BEHAVIOR

While it was not the intention of this study to examine driver behavior, there are qualities in the lateral-acceleration histogram data taken from the tractors of the field study that are noteworthy in this regard. These data tend to suggest that drivers take note of the lateral performance qualities of their vehicles and modify their driving behavior in a fashion to compensate for the perceived shortcomings of their vehicle. We caution at the outset of this discussion, however, that the reader should look upon the following as some interesting observations from the data, but that, in the absence of further study, they do not merit the status of findings. They are speculative, and in the language of the statistician, there is a great deal of potential for the influence of *lurking variables*, not accounted for here. Nonetheless, they are potentially interesting.

Figure 45 shows the lateral-acceleration histograms for the tractors of the loaded triples from the four participating fleets that operated both A-dollies and C-dollies in the study.<sup>41</sup> The upper graph is the full histogram and the lower graph is the magnified view of the area above 0.08 g. The graph distinguishes between triples using A-dollies and C-dollies. Note that the lower graph shows that the tractors of A-train triples spent less time at elevated lateral accelerations than did the tractors of C-train triples. This suggests the hypothesis that drivers are aware of the oscillatory behavior of the trailing units of A-trains and attempt to compensate for this behavior by driving more precisely.

In pursuit of this line of reasoning, a *relative tractor-lateral-acceleration-experience* numeric was developed and used to examine the relative lateral-acceleration experience of the tractors of the six variations of triples, western doubles and Rockies when using A-dollies and C-dollies (loaded vehicles and, again, only for the four fleets that operated both A-dollies and C-dollies fleet).

This relative *tractor* experience measure is virtually identical in form to the relative *trailer* experience numeric of the previous section in that it is calculated from the ratio of performance of one unit to the performance of a reference unit. In this case, the reference performance was the lateral acceleration experience of the tractors of western doubles using C-dollies. (The choice was essentially arbitrary and was made simply because the performance of this tractor fell near the center of the data examined.)

Figure 46 shows the *relative* lateral-acceleration experience of the six classes of tractors investigated. (Note that the measure for the western double tractor using C-dollies is identically one, as a result of using this vehicle as the reference.) Close examination of the graph reveals that (1) tractors of C-trains always fall above tractors of A-trains of the same

<sup>41</sup> Recall that one of the participating fleets had used C-dollies exclusively for several years prior to this study. This fleet would not agree to use A-dollies at all in the field study. Therefore, we have excluded data from this fleet from this analysis.

Puede ser consultado en:

<http://www.hti.umich.edu/cgi/t/text/text-idx?sid=50cf84488b83cc2b8ba0554be1cc5c98;c=umtri;idno=88519.0001.001>

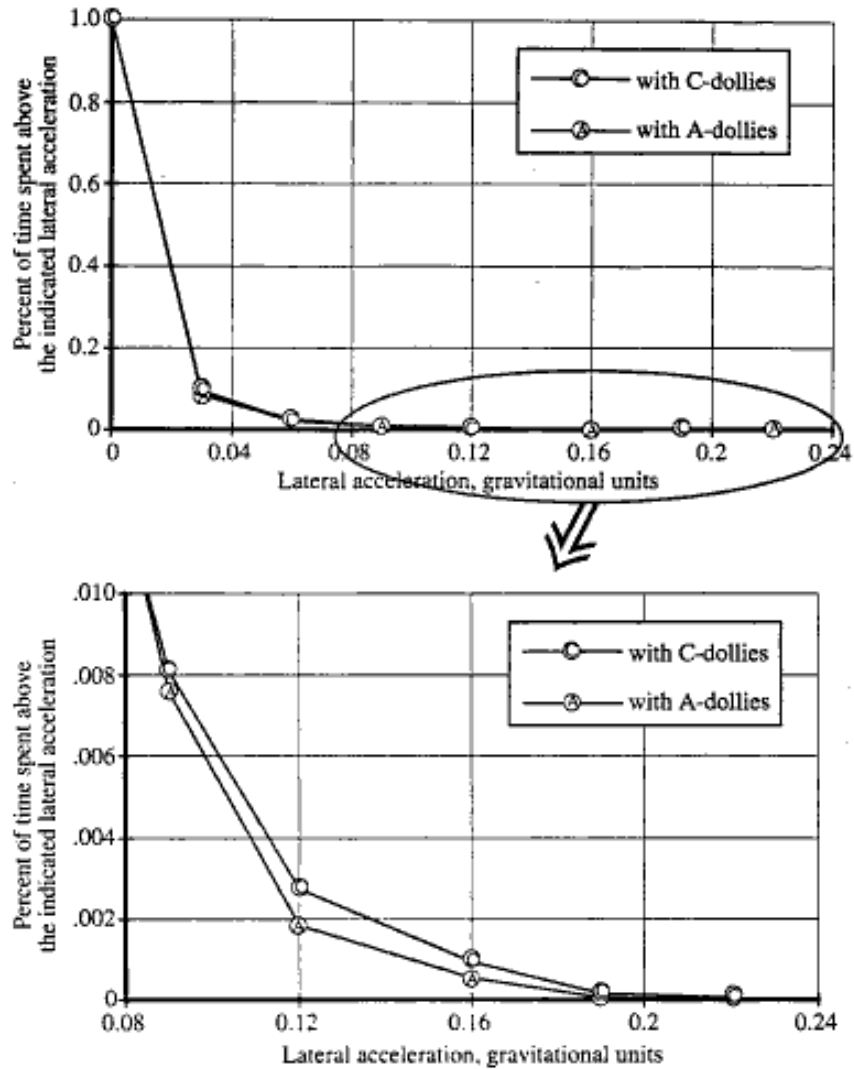
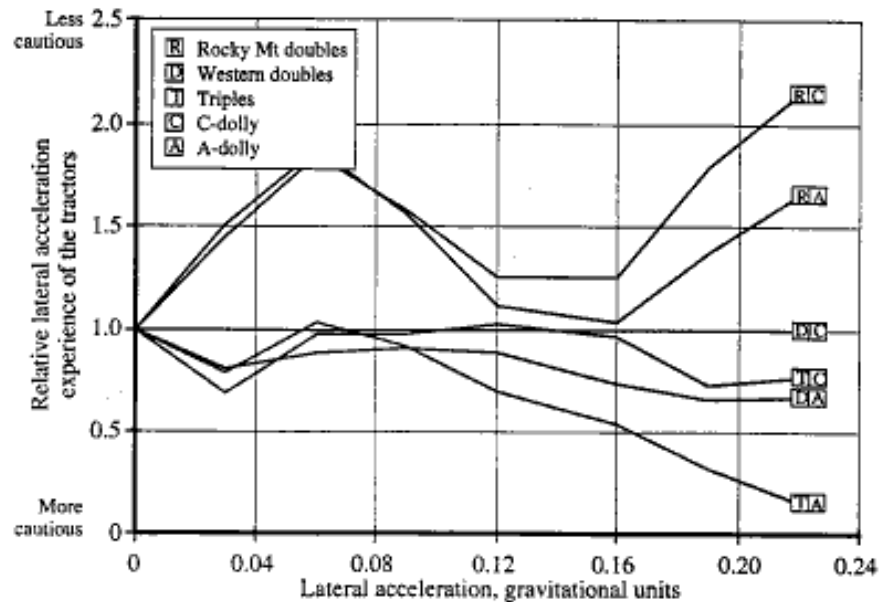

Figure 45. Comparison of the lateral acceleration experience of the tractors of triples when pulling A-dollies and C-dollies, respectively (speeds above 45 mph)

configuration type, and (2) there is a progression from the top to the bottom of the graph of Rockies, then western doubles, then triples.



**Figure 46. Relative lateral acceleration experience of the tractors of loaded LCVs pulling A-dollies and C-dollies, respectively (speeds above 45 mph)**

In order to quantify this observation, these data were examined with a regression model of the following form:

$$\text{REAL}(a_y) = a_0 + a_1 (x_1) + a_2 (x_2) + a_3 (x_3) \quad (2)$$

Where:

$\text{REAL}(a_y)$  is the relative lateral acceleration experience at the specified lateral acceleration,  $a_y$

$a_0 \dots a_4$  are the coefficients of the regression model

$x_1$  is 1 for A-dollies, 0 for C-dollies

$x_2$  is 1 for Rocky Mt doubles, 0 for other configurations

$x_3$  is 1 for triples, 0 for other configurations

Results for this model using  $\text{REAL}(0.22)$  (i.e., at 0.22g lateral acceleration) appear in table 15. The model accounts for the variability in the data rather well ( $r^2 = 0.99$ ). (Similar results derive using data at lateral accelerations of 0.12, 0.16, and 0.19 g with  $r$ -squared values in the 0.92 to 0.99 range.) The model shows that, starting with the reference value of 1.07 for the C-train double, changing to a Rocky Mountain double has a positive influence of 1.07, switching to triples has a negative influence of 0.38, and switching to A-dollies has a negative influence of 0.48.

Puede ser consultado en:

<http://www.hti.umich.edu/cgi/t/text/text-idx?sid=50cf84488b83cc2b8ba0554be1cc5c98;c=umtri;idno=88519.0001.001>

**Table 15. Regression model of the relative lateral acceleration experience of tractors**

$$REAL(0.22) = 1.07 + 1.07 (Rocky) - 0.37 (Triple) - 0.48 (A-dolly) \quad (r^2 = 0.99)$$

Where:

Reference vehicle: Western double with C-dolly (REAL = 1)

Source data: (blanks spaces = 0)

<i>Relative lateral acceleration experience above 0.22 g</i>	<i>Rocky</i>	<i>Triple</i>	<i>A-dolly</i>
0.16		1	1
0.67			1
0.77		1	
1.00 (ref)			
1.66	1		1
2.16	1		

These regression coefficients *imply* that the higher-level-lateral-acceleration experience of the tractor has something to do with the vehicle configuration and dolly type. They tend to support the hypothesis that drivers are reacting to the lateral performance qualities of the vehicle in an attempt to compensate for the rearward amplification properties of their vehicles. However, as noted at the outset of this discussion, potential for the correlations observed to be the result of other variables not accounted for in the model is substantial. Further work is warranted to explore these preliminary observations.



### MAINTENANCE, RELIABILITY, AND OPERATING COSTS OF C-DOLLIES

In this LCV field study, replacing A-dollies with C-dollies appeared to increase overall maintenance costs by about 3 percent for double-trailer combinations and by 5 percent for triple-trailer combinations. Most of these increases in maintenance expense resulted from an 80 percent increase of tire wear rates on C-dollies relative to A-dollies. Continuing maintenance costs associated with the unique features of the C-dolly (the double-tow bar and its hitches, and the self-steering system) appeared minor in relation to increased tire costs. However, appreciable expense for repair of pintle hitches did occur in those fleets with no previous experience with the operation of C-dollies. These were not true *maintenance* costs, but were shown to be strongly related to driver experience, declining rapidly over a driver's first few trips with C-dollies. Presumably, these costs could be substantially reduced with improved driver training or simplified hitching mechanisms.

### SUMMARY OF THE MAINTENANCE COSTS OF A-TRAINS AND C-TRAINS

Figure 47 presents the continuing maintenance costs for typical double-trailer and triple-trailer LCVs as determined in this study. (These values include the unscheduled maintenance costs for all systems, but do not include the costs of regularly scheduled periodic and annual inspections.) The increase in cost associated with operating with C-dollies, which is reflected in this figure, is due almost completely to increased tire wear observed in C-dollies relative to A-dollies. Other continuing maintenance expenses

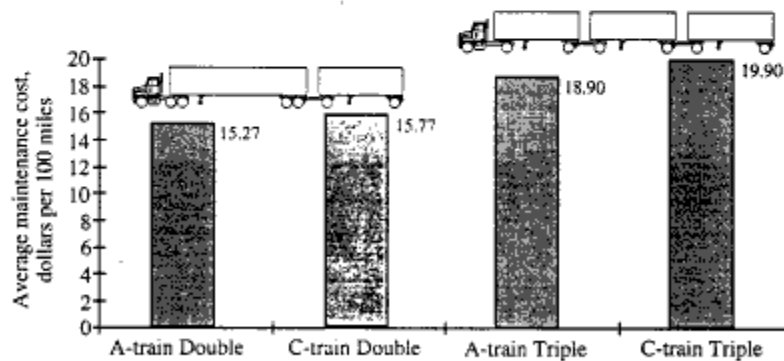

Figure 47. Maintenance costs for LCVs using A-dollies and C-dollies



**Table 16. Maintenance cost for C-trains and A-trains**

<i>Costs per 100 miles for:</i>	<i>Doubles</i>		<i>Triples</i>	
	<i>C-train</i>	<i>A-train</i>	<i>C-train</i>	<i>A-train</i>
<i>Tires</i>	3.52	3.08	5.15	4.27
<i>All other items<sup>†</sup></i>	12.25	12.19	14.75	14.63
<i>Total</i>	15.77	15.27	19.90	18.90

<sup>†</sup> These costs do not include the expense of periodic and annual inspection on trailers and dollies.

associated with C-dollies are relatively insignificant. The cost values supporting these observations are presented in table 16. The table presents the same data as the figure but also discriminates between tire costs and the maintenance expense for all other systems.

Figure 48 shows the typical maintenance costs of the individual units of an LCV (from which the previous figure was constructed).<sup>42</sup> Of course, the most expensive unit is the tractor with a cost of \$9.05 per 100 miles (CPCM). Van trailers typically have a CPCM of about \$2.59. The C-dollies and A-dollies have a CPCM of \$1.54 and \$1.04, respectively. Table 17 presents these values along with the breakdown between tire costs and the costs of all other systems. The figures of the table show that tires contribute more than one half of the total maintenance expense of A-dollies. In relation to this, tire expense for C-dollies is about double that of A-dollies, which amounts to a 50-percent increase in total maintenance cost of C-dollies relative to A-dollies.

Details of the bases for the numerical values presented in the figures and tables of this section follow.

### **TIRE WEAR AND COSTS FOR A-DOLLIES AND C-DOLLIES**

Tires represent the largest, single, maintenance-cost item for dollies and are 50 percent or more of the total maintenance costs of dollies. Nonetheless, tire costs were the most difficult element of the maintenance expense of dollies to quantify in this study.

The policies and practices of tire use vary considerably among the five fleets participating in the LCV field study (and, indeed, among commercial fleets in general). Some fleets use dollies to *run out* older tires that were initially used on their power units, while other fleets buy new tires for their converter gear. Further, the duration of the LCV study was not sufficient to experience a representative number of tire changes on the units

<sup>42</sup> Detailed discussion of the basis for costs for trailers was presented previously in the chapter on ABS maintenance and reliability. Similar discussion of the details for costs associated with A-dollies and C-dollies follows in this section. The basis for tractor costs is presented in appendix K.

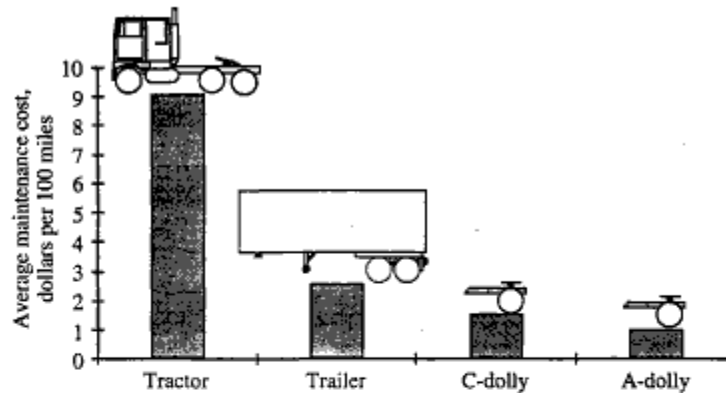

Figure 48. Maintenance costs for tractors, trailers, and dollies

Table 17. Maintenance cost for individual units

Costs per 100 miles for:	Tractors	Trailers	C-dolly	A-dolly
Tires	1.25	0.64	0.99	0.55
All other items <sup>†</sup>	7.80	1.95	0.55	0.49
Total	9.05	2.59	1.54	1.04

<sup>†</sup> These costs do not include the expense of periodic and annual inspection on trailers and C- and A-dollies.

in the study, thereby establishing costs within the study. (All C-dollies started the project with new tires and the average C-dolly accumulated 64,800 miles during the project.)

In the face of these difficulties, the approach taken to address tire cost was to (1) establish representative tire wear rates for both A-dollies and C-dollies, (2) establish representative tire costs for A-dollies from several data sources, and (3) estimate tire costs for C-dollies based on the tire cost for A-dollies and the relative wear rates of the two types of dollies.

#### Tire Wear For A-Dollies And C-Dollies

Tire tread wear records were kept on every tire of every unit in the field study (seventeen tractors, eighty-six trailers and twenty-eight C-dollies) plus ten additional A-dollies distributed among the fleets.<sup>43</sup> Tread depth measurements were made by the project

<sup>43</sup> A total of sixteen A-dollies were followed in the study. However, adequate tread depth information could only be tracked on ten of these.

ESTUDIO DE INVESTIGACIÓN DE LA UNIVERSIDAD DE MICHIGAN

Puede ser consultado en:

<http://www.hti.umich.edu/cgi/t/text/text-idx?sid=50cf84488b83cc2b8ba0554be1cc5c98;c=umtri;idno=88519.0001.001>

field representative who visited each fleet for this purpose monthly throughout the study. The resulting data were analyzed using linear regression techniques to obtain representative measures of tire wear rates for A-dollies and C-dollies, respectively. Additionally, some of the participating fleets maintained records in a fashion that allowed determination of tire wear rates for A-dollies and C-dollies, respectively. The representative tire wear rates obtained by these methods are given in table 18. Details appear in appendix M.

Table 18 indicates that during the study, the tires of the C-dollies wore at an average rate of 1/32 of an inch per 17,493 miles. Tires on the dollies in fleets B and C wore more rapidly at 1/32 inch per 12,126 and 12,824 miles, respectively. The poor tire wear performance of the units in fleet C is explained by the occurrence of wheel-alignment problems with two of their C-dollies. (The result was very rapid tire wear for a brief period, which underscores the importance of closely monitoring tire wear for early indication of misalignment with the C-dolly.) It is not clear why the tires on the C-dollies operated by fleet B wore so rapidly. Perhaps this result is simply unrepresentative, due to the fact that the C-dollies in this fleet were underutilized. These dollies traveled an average of only 18,600 miles during the study, compared with an average of 64,800 miles for all the C-dollies. Fleets D and E had the best wear rates: 1/32 inch in about 21,000 miles. Fleet

**Table 18. Tire wear rates for A-dollies and C-dollies**

<i>Source</i>	<i>No. of Units</i>	<i>Total Miles</i>	<i>Average Miles per Unit</i>	<i>Miles per 1/32 inch of tire wear</i>
<b>Tire wear for C-dollies of the study by fleet</b>				
<i>Fleet A</i>	3	133,826	44,609	16,616
<i>Fleet B</i>	6	111,522	18,587	12,126
<i>Fleet C</i>	4	261,588	65,397	12,824
<i>Fleet D</i>	9	759,899	84,433	20,804
<i>Fleet E</i>	6	299,960	49,993	21,365
<b>Tire wear for A-dollies and C-dollies from the study and historical records</b>				
<i>Study C-dollies</i>	28	1,566,795	55,957	17,493
<i>Historical C-dollies</i>	17	1,918,533	112,855	17,600
<i>Study A-dollies</i>	10	427,581	42,758	33,572
<i>Historical A-dollies</i>	9	1,774,498	197,166	31,965
<b>Representative tire rates for all A-dollies and C-dollies</b>				
<i>All C-dollies</i>	45	3,485,328	77,452	17,550
<i>All A-dollies</i>	19	2,202,079	132,538	31,908

D had been operating C-dollies prior to the study; their experience may be reflected in this better wear rate.

On average, the wear rates determined within the study and those determined from the historical records of the fleets agree very well. We do note, however, that the wear rate of C-dollies from the historical records, which are from fleet D, show variance with the experience of C-dollies operated by fleet D during the study. Nonetheless, the general agreement suggests that these are representative results.

The overall results show tire wear rates of 1/32 inch per 17,550 and per 31,908 miles for C-dollies and A-dollies, respectively. This 1.8-to-1 ratio of tire wear between the two dolly types is obviously very significant in that it implies a 1.8-to-1 ratio of tire costs. The basis for estimating the resulting costs follows.<sup>44</sup>

#### Tire Costs For A-Dollies And C-Dollies

A tire-cost rate of \$0.55 per 100 miles was established for the operation of A-dollies. This rate was based on the historical records for A-dollies and the accumulation of tire costs and mileage by twelve A-dollies from three of the participating fleets that were followed in this study.<sup>45</sup> Table 19 shows the total cost, miles traveled, and costs per 100 miles for the A-dollies followed during the study and as derived from the historical maintenance records of two of the participating fleets.<sup>46</sup>

As a group, the twelve A-dollies followed during the study had a tire-cost rate of \$0.537 per 100 miles. This rate is based on a total of 0.8 million miles of service and a total tire-maintenance cost of \$4,298 for both parts and labor. The rates vary considerably from \$0.213 to \$0.93 per 100 miles. These differences may be real, or they may be an artifact resulting from the short period of observation in the study. In any case, the rate for all these A-dollies taken as a group compares well with the rate determined from other sources.

<sup>44</sup> There is a reasonable argument which suggests that this ratio is too large. The better tire wear performance of C-dollies operated by fleet D during the study may reflect this fleet's experience in operating C-dollies. (Later sections will show that this experience is important with respect to other costs.) Also, the requirement that dollies purchased by the study adhere to the Canadian performance standards may have adversely affected tire wear for these dollies (all but fleet D). [10, 11] Under these more favorable assumptions, the ratio of tire wear on C-dollies and A-dollies would be about 1.6 to 1.

<sup>45</sup> In total, sixteen A-dollies from four of the participating fleets were followed during the study. However, in one fleet, four of these dollies traveled 262,492 miles with no tire maintenance records being found on file at the distribution center. Unlike the primary units of the study, these A-dollies were not constrained to operate from a single distribution center. We believe it likely that maintenance was done on these units at other distribution centers and those records were not available to the project. Purely on the basis of this judgment, those dollies have been dropped from this calculation.

<sup>46</sup> Only two of the participating fleets maintained records in a manner adequate to determine tire costs on a per mile basis for A-dollies.

**Table 19. Tire costs for A-dollies**

	<i>Total cost, dollars</i>	<i>Miles traveled</i>	<i>Cost rate, dollars per 100 miles</i>
<b>Tire maintenance costs for the sixteen A-dollies of the study by fleet</b>			
<i>Fleet A</i>	1,602	335,166	0.478
<i>Fleet B</i>	485	227,816	0.213
<i>Fleet C</i>	2,212	237,765	0.930
<i>All Study Dollies</i>	4,298	800,747	0.537
<b>Tire maintenance costs from historical records of twelve A-dollies</b>			
<i>Fleet H-A</i>	14,519	2,615,392	0.555
<i>Fleet H-B</i>	8,359	1,553,885	0.538
<i>All Historical</i>	22,877	4,169,277	0.549
<b>Tire maintenance costs for A-dollies</b>			
<i>All A-dollies</i>	27,175	4,970,024	0.547

Of the \$4,298 incurred for tire maintenance for these A-dollies, \$1,214 (28 percent) were the result of buying and mounting new tires. A total of \$2,862 (67 percent) were the result of recapping and mounting used tires. The remaining \$222 (5 percent) were associated with other tire expenses such as flat repairs or tire rotation.

The historical records of eight A-dollies in one fleet (H-A) and three in another fleet (H-B) showed a tire-cost rate of \$0.549 per 100 miles. This rate is based on a total of 4.2 million miles of service and total tire-maintenance costs of \$22,877 for both parts and labor. Of this \$22,877 total, \$12,348 (54 percent) were a result of the costs of buying and mounting new tires. A total of \$8,929 (39 percent) were a result of the costs of retreading and mounting used tires. The remaining \$1,601 (7 percent) are associated with other tire expenses, such as flat repairs or tire rotation. The historical records for the dollies of fleet H-A covered a five year period between October of 1988 and November of 1993. The historical records for the dollies of fleet H-B covered a 7.5 year period between January of 1988 and May of 1995.

The authors recognize that this is a rather limited basis on which to establish tire costs, but data resources were severely limited.<sup>47</sup> However, the consistency of the cost rates

<sup>47</sup> Adequate mileage data for normalizing costs are difficult to obtain, especially for trailers and dollies. Very few fleets use hubometers on trailers and even fewer use them on dollies. For fleets hauling only single semitrailers, a good estimate of average trailer mileage can be made using tractor mileage, which is closely tracked by most fleets. In LCV operations, however, this estimating technique is far

observed in the study fleet and in the historical records is encouraging. It is also noted, that the rate of \$0.547 per 100 miles is very dependent on the specific practices of the study fleets which included using a mix of new and recapped tires. Certainly, other tire-maintenance practices could result in substantially higher or lower tire costs.

### COMPARISON OF MAINTENANCE COSTS FOR C-DOLLIES AND A-DOLLIES

In addition to estimating the differences in tire wear and tire costs between C-dollies and A-dollies, all other maintenance costs for both C-dollies and A-dollies were measured. These costs were subdivided according to seven systems defined as follows:

- Brakes - This system includes all brake valves, chambers, hoses, air reservoirs, foundation material, slack adjusters, and all miscellaneous brake parts.
- Coupling - This system includes all parts associated with the fifth wheel and pintle hitch such as release handles, eye hooks, and trailer mounted hitching mechanism.
- Electrical - This system includes wires, lights, fuses, junction boxes, switches, connectors, and other miscellaneous electrical components.
- Frame - This system includes the frame, dolly jack, suspension components, and axle.
- Steering - This system is unique to the C-dolly. The steering system includes the damper, valves, and all miscellaneous parts associated with the control of the self-steering action of the dolly wheels.
- Trim - This system includes items such as mud flaps, quarter fenders, chain hangers, brackets, etc.
- Wheels - This system includes hubs, studs, wheel seals, bearings, rims, etc.

Figure 49 compares the maintenance costs for C-dollies and A-dollies according to these seven major systems. The individual rates are derived from both the experience of the study and from historical maintenance records for A-dollies and C-dollies. The rates derived from each of these sources, and their averages for C-dollies and A-dollies respectively, are presented in table 20.

Figure 49 shows total *unadjusted* CPCMs for all C-dolly and A-dolly maintenance of \$0.41 and \$0.49, respectively. Among the individual system costs, only those for brakes and steering systems show appreciable differences between C-dollies and A-dollies. The steering system is, of course, unique to the C-dolly and represents a true additional cost. We believe, however, that the low cost of brake maintenance (\$0.07) for C-dollies reflected in this figure and in table 20 is probably not representative, but is an artifact of the study. (An explanation follows later in this chapter.) There is no fundamental difference between

---

less reliable since the number of trailers and dollies pulled by a tractor varies from trip to trip and even during a given trip.

the brake systems of C-dollies and A-dollies that can explain this cost difference. Therefore, the cost rate for C-dolly brake maintenance has been *adjusted* to equal the rate determined for A-dollies. This increases the total CPCM for C-dollies from \$0.41 to \$0.55. These changes are shown in figure 49 but have not been included in table 20. Comments made earlier on the overall maintenance costs of C-dollies and C-trains were based on the adjusted rate. A detailed discussion of the sources of all the values in table 20 follows in the next section.

Finally, it is noted that there were significant additional costs incurred by those fleets that had no previous experience with C-dollies. These costs were related to the pintle hitches installed on trailers for the double-tow-bar C-dollies. As will be explained in some depth in the next section, they were not true maintenance costs, but were closely associated with driver training. In this study, hitch-system expenses of approximately \$100 were associated with the first thirty trips taken by a driver otherwise inexperienced with the use of the C-dolly.<sup>48</sup> This cost is not fixed and could be reduced by improved driver training or an improved hitch design.

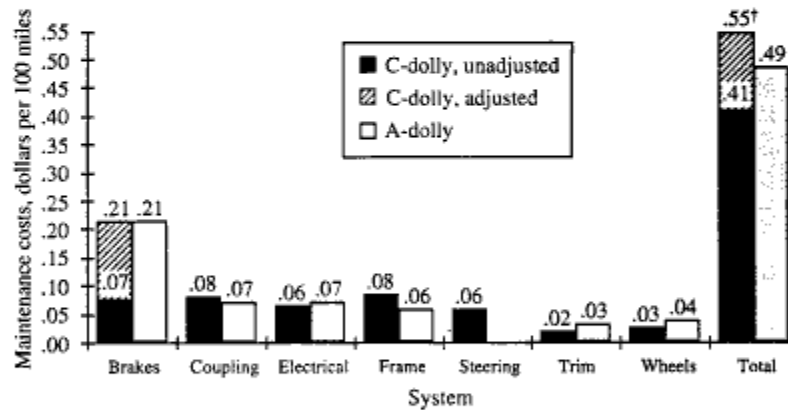

† This total cost rate was used for C-dollies in the previous section comparing C-train and A-train costs.

**Figure 49. Summary of the maintenance costs of all C-dollies and A-dollies in dollars per 100 miles**

<sup>48</sup> This cost is probably not representative. We expect that it is too high due to some of the artificial conditions brought on by the study.

**Table 20. Summary of the maintenance costs of C-dollies and A-dollies in dollars per 100 miles**

System	C-dollies		A-dollies		All sources	
	Study	Historical	Study	Historical	C-dollies	A-dollies
Brakes	0.093	0.066	0.278	0.197	0.074	0.213
Coupling	0.047	0.097	0.052	0.076	0.081	0.071
Electrical	0.106	0.046	0.063	0.074	0.065	0.072
Frame	0.131	0.064	0.019	0.079	0.084	0.060
Steering	0.038	0.071	0.000	0.000	0.060	0.000
Trim	0.031	0.014	0.037	0.031	0.019	0.032
Wheels	0.031	0.025	0.053	0.036	0.027	0.040
Total	0.477	0.381	0.501	0.492	0.411	0.487

#### MAINTENANCE AND RELIABILITY OF C-DOLLIES IN THIS STUDY

All work orders and maintenance records maintained by the five participating fleets for the twenty-eight C-dollies of the LCV field test from August 1993 through April 1995 were collected. These, along with all problem reports generated by the study, became the basis for establishing the continuing maintenance costs of C-dollies.

A total of 250 problems were reported during the program. Of these problems, eight were found to be peculiarly related to the installation of hitching hardware or other elements of the startup of this field study. There were also a large number of problems related to the special bell-mouth pintle hitches used with the C-dollies. Most of these problems were related more to issues of driver training than to continuing maintenance issues. The remainder of the reported problems were each identified with one of seven major dolly systems defined previously. Finally, one of the participating fleets experienced very high expenses resulting from damage to dolly jack legs. These costs were seen as so anomalous that they were removed from consideration with respect to both A-dollies and C-dollies.

The next three subsections will address the eight startup problems, the driver training issues, and the excessive costs due to damage of the jack legs, respectively. These sections are followed by a discussion of the reliability and maintenance costs of the study C-dollies, the historical C-dollies and the study and historical A-dollies, respectively. The last subsection presents, as additional reference, data on the maintenance costs of A-dollies from sources outside of this field study.



### Startup And Installation Problems

There were eight problems that could be clearly related to the initial installation of hardware or other elements of the startup of the LCV field study. A description these problems follows:

- Five problems involved the C-dolly brake system. Four of these were for the installation of filters in the air lines of the dollies at one fleet. This fleet normally uses such filters, and despite efforts to customize the field test dollies in accordance to fleet practices, these filters were overlooked during the specification process early in the study. The total standardized cost for these repairs, including parts and labor, was \$117. The fifth brake system problem involved replacing a release valve on a dolly at the same fleet. The failure occurred because small pieces of gravel contaminated the valve. This problem was considered a startup problem because it would not have happened had the dollies initially been specified with in-line filters. This problem cost \$95 to repair.
- Three startup problems involving the frame system all occurred in one particular fleet. This fleet is unique inasmuch as it experiences damage to dolly jack legs and caster assemblies at a very high rate. In order to better maintain the test dollies, the original, relatively light-duty, dolly jack legs were replaced with the more rugged style used routinely by this fleet. The total reported cost for this modification was \$736.

### Problems Of Driver Training And Inexperience

Problems associated with the double-tow-bar hitching system of the C-dolly were seen to be strongly associated with the amount of experience (or inexperience) that the driver previously had with C-dollies. This section examines the record of these types of hitching problems in the LCV field study in an attempt to separate expenses of a *continuing maintenance* type and those associated with *driver inexperience*.

All the drivers who participated in the LCV field study were experienced in operating LCVs. Further, the fleet operating out of Boise had been using C-dollies since 1988 and was using them exclusively in their Boise operations before the start of this study. Hence, the drivers of this fleet were experienced in using C-dollies.

In contrast, none of the fleets operating out of Portland, or any of their drivers, had any real experience with C-dollies prior to the study. As noted elsewhere, UMTRI, in cooperation with the C-dolly manufacturer, ITR, provided training in the use of C-dollies for the personnel of the Portland fleets. Nonetheless, observations made in the course of the study made it clear that this training was not completely sufficient and that drivers experienced a disproportionate number of problems with the double-tow-bar hitching system early in their experience with C-dollies.

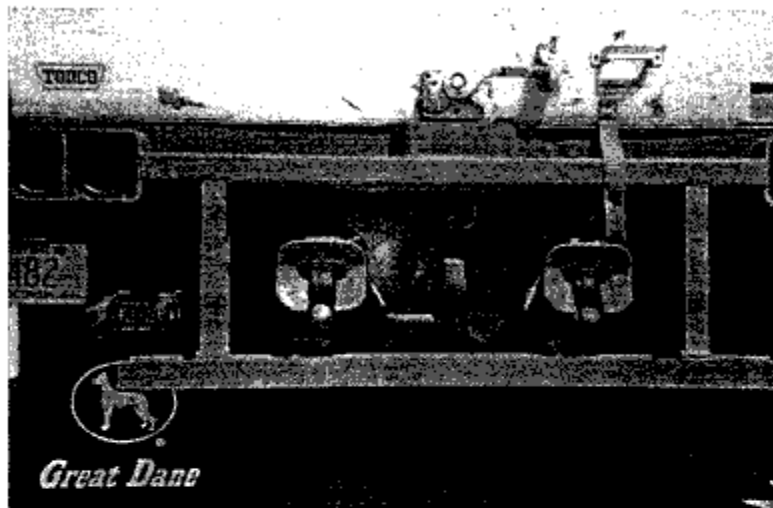
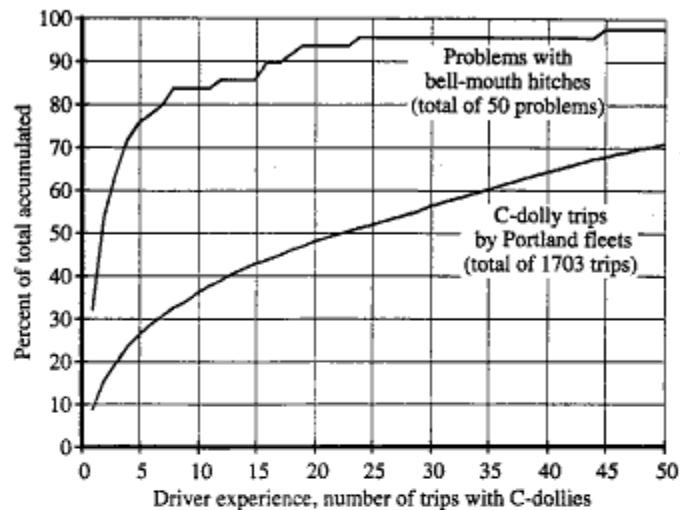

Figure 50. Photograph of a conventional drop-on pintle hitch (center) and the bell-mouth pintle hitches used with C-dollies in the LCV field study

Unlike A-dolly operations, which typically employ a *drop-on* style of pintle hitch, the pintle hitches supplied for the C-dolly operations of the filed study were of the *bell-mouth* variety in which the tow ring is intended to engage the hitch *straight in* on a horizontal course. The two styles of hitches appear in figure 50. (For more details on the bell-mouth hitch, see appendix E.)

Operation of this bell-mouth hitch is both *different* and somewhat *more complicated* than operation of the drop-on style of hitch. (A brief discussion of the drivers' difficulty with this hitch and comments by the manufacturer appear in appendix E. Written comments from drivers can be found in appendix C.) Both of these factors imply a need for driver training. Correct procedures for hitching the C-dollies using the bell-mouth hitch were one element of the training sessions provided by UMTRI, ITR, and the ABS suppliers at the start of the field study. Not all the drivers who participated in the field study were able to attend these training sessions, so additional driver training was provided throughout the study by UMTRI's representative in the field.<sup>49</sup>

<sup>49</sup> Some drivers could not attend the training sessions due to schedule conflicts. Many more entered the program after the training sessions had taken place. Also, UMTRI and ITR were not allowed to train the drivers of one fleet directly. This fleet preferred to provide driver training themselves through management personnel who had attended the training sessions. This fleet operated about 10 percent of the twenty-eight C-dollies but was the source of 45 percent of the hitch problems under discussion.



**Figure 51. The accumulation by the Portland fleets of problems with the bell-mouth hitches used with C-dollies and of trips with C-dollies, respectively, as a function of driver experience with C-dollies**

Despite these training efforts, the data clearly indicated that drivers of the Portland fleets were not fully prepared and, therefore, experienced a disproportionate number of problems with the bell-mouth pintle hitches in their early experience with C-dollies. On the other hand, the drivers from Boise, who were experienced with C-dollies, reported no problems with these hitches throughout the field study.

Figure 51 derives from the experience of the *Portland* fleets only. It shows, as a percentage of total, (1) the accumulation of their problems with the bell-mouth hitches and (2) the accumulation of their LCV study trips.<sup>50</sup> Both are presented as functions of driver experience. Experience is expressed, on the horizontal axis, as the number of trips that the driver involved had taken using C-dollies.<sup>51</sup>

Starting from the extreme left of the figure, it can be seen that some 33 percent of the hitch problems reported occurred when drivers were on their very first trips with C-dollies.

<sup>50</sup> In this discussion, the term "trip" does not refer to a complete round trip, but rather to a segment of a trip during which a specific vehicle configuration and loading condition is maintained. Typically, a driver would be involved in hitching and/or unhitching dollies at the start and/or end of each such segment.

<sup>51</sup> There were a total of fifty-six problems reported with bell mouth hitches. Fifty of these were reported by drivers and could be assigned to specific trips. The remaining six were reported by hostlers or maintenance people and are not included in this graph.

even though less than 10 percent of the trips by Portland drivers were such first trips. The trend continues: Over 75 percent of the problems occurred in the drivers' first five trips, but those trips are just 26 percent of the total, and 94 percent of the problems were experienced in the drivers' first twenty trips with C-dollies, which are just 48 percent of the total trips.

Note that this graph could be extended out to 271 trips since one driver in the Portland fleets accomplished this number of trips with C-dollies during the study. If this were done it would be revealed that the last reported hitching problem was related to the ninety-ninth trip of one driver's experience. That is, no problems were reported by Portland drivers who had experienced at least one hundred trips with C-dollies. In this regard, it is probably more significant that the drivers of the Boise fleet accomplished 1,402 trips with C-dollies with no problems of this kind reported. It would seem safe to presume that these drivers all had at least one hundred trips with C-dollies prior to the LCV study since their company had been using C-dollies for three years prior to the field study.

Figure 52 derives from the same data used to produce figure 51. Here, the rate of problems with bell-mouth hitches is expressed as problems per trip, again as a function of driver experience. Presented in this way, the data show a high rate of problems in a driver's first five trips—0.85 problems/trip or one problem every 1.2 trips. But this rate falls off in a manner suggesting that the drivers learned rapidly in the first few trips and

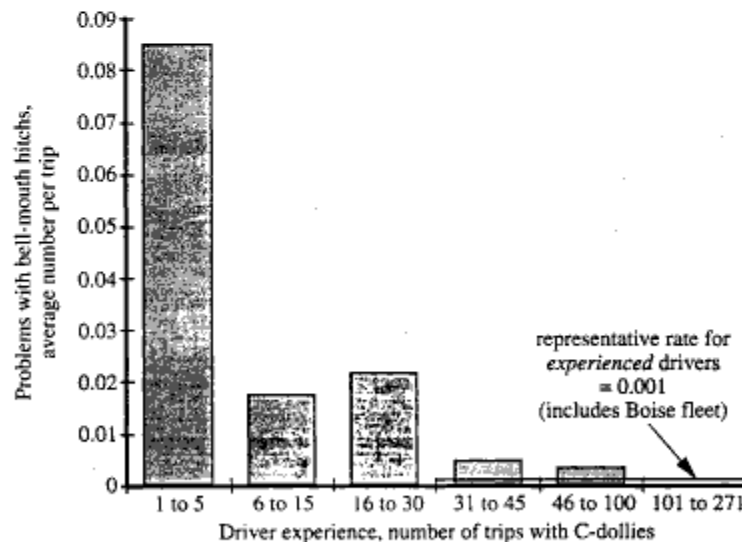

Figure 52. Problems per trip with the bell-mouth hitches used with C-dollies in the Portland fleets as a function of driver experience

continued to gain valuable experience over at least their first thirty trips. In the range of thirty-one to forty-five trips, however, the rate at which problems occur dropped to 0.005 problems per trip, or one problem in every 200 trips. After one hundred trips, the rate of problems experienced in this study was zero.

These treatments of the data clearly indicate that a large proportion of the problems experienced with the bell-mouthed hitches are *initial* problems associated with driver experience, that is, not of a *continuing* nature. However, it is not likely that the representative rate of *continuing* problems is zero. Accordingly, we have made the rather arbitrary decision of assuming that all problems occurring after thirty trips with C-dollies are of a continuing nature. When the data of the Boise fleet (all trips by *experienced* drivers) are combined with the appropriate portions of the data from the Portland fleets, this assumption yields a rate of continuing, or maintenance, problems of 0.001 problems per trip or one problem every 1,000 trips.<sup>52</sup> This representative rate is indicated by the horizontal line on figure 52.

The rate of 0.001 problems per trip implies that 3.24 of the fifty-six hitching problems reported in the study should be considered as maintenance problems. At an average cost of \$110 per problem and with a total of 1.8 million C-dolly miles, this amounts to a CPCM of \$0.020.<sup>53,54</sup> This cost rate is used to represent this particular class of problems in the other analyses of this chapter.

There remains the problem of expressing the expense associated with each new driver becoming experienced in the use of C-dollies. Assuming that a driver becomes *experienced* after thirty trips with C-dollies, *this study* (and its attendant level of training), suggests a rate of 0.9 problems per driver. Based on an average cost of \$110 for this type of problem, this amounts to \$99 per driver.<sup>55,56</sup> Clearly, this cost could be reduced either by improved training (relative to the training done in this study) or by design changes which simplify the use of the hitch.

#### Excessive Frame Costs Due To Damage Of The Jack Leg

Most frame costs observed in this study were a result of damage to dolly jack legs. One fleet in particular had an unusually high rate of damage to their jack legs on both C-dollies and A-dollies. As a result, and depending on the data source, maintenance costs for the

<sup>52</sup> This calculation also accounts for the six problems which could not be assigned to specific trips.

<sup>53</sup> The rate of \$110 per incident is probably artificially high due to the fact that hitches were often replaced immediately upon complaint to expedite the progress of the study. See appendix E.

<sup>54</sup> Note that this rate is so low that the effect on overall continuing maintenance costs is small. Choosing 100 trips as the threshold would result in zero continuing maintenance cost for this item, but would have little influence on the overall maintenance costs of LCVs.

<sup>55</sup> Again, the rate of \$110 per event is probably high.

<sup>56</sup> This rate of \$99 per driver is more sensitive to the choice of the division point. Assuming 100 trips are required to become experienced, this cost rises to \$127 per driver.

frame system for this fleet were as much as sixty-five times greater than the average costs for the other four fleets in the study. Due to this anomaly, the costs for jack leg maintenance for this fleet were excluded from the calculation of average frame-maintenance cost throughout this study. Details of the costs for jack leg maintenance follow. (The fleet that has been discounted in this category will be referred to as fleet X in this discussion.)

*Maintenance costs for the repair of jack legs on C-dollies in the field study*

A total of forty-eight repairs or replacements of jack legs were required for the twenty-eight C-dollies of the field study. These repairs had a total cost of \$3,578.50 and an average repair time of 0.7 hours. Thirty (63 percent) of the repairs occurred in fleet X. These thirty repairs had a total cost of \$1,376.75 (38 percent), a CPCM of \$1.03, and occurred, on average, every 4,400 miles. The other four fleets averaged a repair of this type every 93,410 miles with a CPCM of \$0.13.

*Maintenance costs for the frame system of A-dollies at fleet X*

The three A-dollies of fleet X that were followed during the study suffered frame maintenance costs at a rate of \$1.237 per 100 miles due to ninety-two jack leg repairs or replacements in a total of 335,000 miles. This rate is some sixty-five times higher than the average rate of \$0.019 experienced by the A-dollies that were followed in the other participating fleets.<sup>57</sup>

The frame costs taken from the historical records for A-dollies indicated a CPCM of \$0.670 for fleet X and an average CPCM of \$0.079 for another fleet.

**Maintenance And Reliability Of C-Dollies In The LCV Field Test**

Of the 250 problems experienced by the C-dollies in this study, eight have been associated with startup and installation problems, fifty-three with problems of driver training and inexperience, and thirty with the excessive rate of damage to dolly jack legs at fleet X. The remaining 159 problems are considered to contribute to the continuing maintenance cost of C-dollies. The total expense for parts and labor needed to correct these problems was \$8,478, or an average of \$303 for each of the twenty-eight C-dollies. The C-dolly fleet traveled approximately 1.81 million miles during the study (64,839 miles per unit) yielding an overall CPCM of \$0.477. Table 21 summarizes the problem counts and costs for the seven classifications previously defined.

The most expensive systems were frame, electrical, and brakes. These three systems combined had a CPCM of \$0.330, or 69 percent of the total CPCM for maintenance of these seven systems. The remaining four systems, two of which embody the defining characteristics of the C-dolly (coupling and steering), had relatively low costs.

---

<sup>57</sup> The CPCM of \$0.019 is small partly because two of the three fleets had no frame costs at all.

Detailed discussion of the problems with each of these seven systems follows.

**Table 21. Summary of maintenance problems and costs of the C-dollies of the field study**

System	No. of Problems	Labor Time (hrs)	Labor Costs (\$)	Parts Costs (\$)	Total Cost (\$)	Cost per Unit (\$)	Cost/100 Miles (\$)
Brakes	37	28.86	1,010	677	1,687	60	0.093
Coupling	14	10.44	366	496	862	31	0.047
Electrical	45	44.09	1,543	380	1,923	69	0.106
Frame	21	25.15	880	1,322	2,202	79	0.131
Steering	21	13.74	481	204	685	24	0.038
Trim	11	6.45	226	331	557	20	0.031
Wheels	10	10.95	383	179	562	20	0.031
Total	159	139.68	4,889	3,589	8,478	303	0.477

#### *Brake system*

For the purposes of this study the brake system includes all brake valves, chambers, hoses, air reservoirs, foundation brakes, slack adjusters and all other miscellaneous brake parts. During the study a total of thirty-seven brake system problems were reported for the program. They ranged from a simple brake adjustment to a \$782 road repair. The total accumulated standardized cost of these problems, both parts and labor, was \$1,687.47 (\$60.27 per unit).

Figure 53 shows the accumulation of costs for an average C-dolly as a function of accumulated miles. Of the thirty-seven problems represented, five were classified as erroneous reports. In all five cases (four occurring at one fleet), drivers reported an air leak, but upon closer inspection by mechanics, no problems were found. These erroneous reports were attributable to drivers who did not understand how the parking brake system worked in combination with an ABS modulator valve.

There were a total of thirty-one normal brake repairs. These were typical brake system problems and were primarily due to air-line leaks, glad-hand and check valve repairs, and brake adjustments. The average labor time to repair these problems was 0.56 hours with an average repair cost of \$27.34 including parts and labor.

There was one significant road service call reported during the study. The driver commented on his trip form that "the brakes would not release because of a valve problem." A road breakdown form was filed and a local repair facility was called for assistance. The repair facility towed the dolly, performed a thorough inspection of the unit,

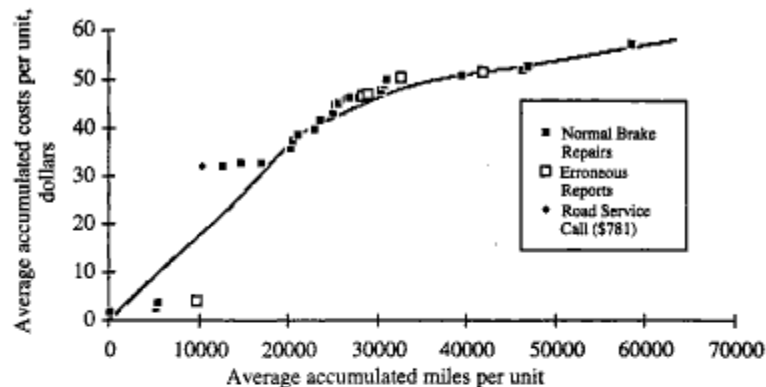

**Figure 53. Average accumulated costs per unit for the maintenance of the brake system of C-dollies**

and replaced the ABS valve with a standard valve and replaced another air control valve on the dolly. The cost of the repair was \$441 in parts and \$340 in labor. The suspected ABS valve was sent to the manufacturer, Allied Signal, for inspection and diagnosis. This investigation showed the valve had no defects, and it was returned to the fleet for reinstallation. The other valve involved in the incident was returned to its manufacturer under their standard core replacement program and was not specially inspected.

It should be noted that the fleet involved in this incident routinely uses brake line antifreeze. During the course of this study, Allied Signal issued a service alert and eventually recalled its modulator valves in connection with difficulties arising from exposure to brake line antifreeze. (The manufacturer of the other valve also objects to the use of such antifreeze.) However, Allied Signal personnel were not convinced this was the cause of the original brake release problem. Because other reports by this fleet indicated their drivers had trouble understanding how the spring brakes and ABS valves worked, it was postulated that this driver and the repair person also did not understand the system and made unnecessary changes. The cause of this problem was never fully resolved. Although the problem is included in the brake system costs, it was unique. During this study, or in the historical C-dolly data, there were no other service calls on the C-dolly brake system that required this level of effort or expense.

The average rate at which brake maintenance costs occurred over the entire study was \$0.093 CPCM. This result is less than the \$0.213 CPCM that represents the average brake system costs for A-dollies as determined from the study and historical records of the participating fleets. This is not surprising since none of the C-dollies had a major brake system overhaul during the study. Historical records show a brake overhaul for a single



axle can cost approximately \$200 in parts and labor, which is eight times the costs of the average brake system repair in this study.

#### *Coupling system*

The coupling system includes all parts associated with the fifth wheel and with the pintle hitch systems such as release handles, eye hooks, and trailer-mounted hitching mechanism. During the study there were sixty-seven coupling problems and maintenance reports for the C-dollies.

Fifty-six of the coupling problems were associated with the special bell-mouth pintle hitches used with the C-dollies of this study. These problems were examined in much detail in the previous section of this study dealing with the problems of driver inexperience. Of these fifty-six problems, fifty-three were considered to be related to driver inexperience and the expenses related to those problems are therefore not applied to continuing maintenance costs.<sup>58</sup> The maintenance-cost rate associated with the remaining three problems with bell-mouth hitches was found to be \$0.020 per 100 miles.

Nine of the remaining eleven coupling problems were not necessarily unique to C-dollies and included repairs like fifth-wheel adjustments and straightening of fifth-wheel release handles.

The remaining two problems involved replacement of two pintle eyes at one fleet. Both eyes were replaced because of cracking. Upon inspection, ITR found that only one of the two eyes had fractured.<sup>59</sup>

Figure 54 shows the accumulation of coupling costs for these eleven problems. The erratic nature of the plot results from the relatively high cost of replacing the two eyes. The total cost to replace these two eyes was \$240 in parts and labor. For all eleven problems, a total of \$505.25 (\$18.04 per unit) was spent, and each averaged 0.28 hours to repair. The maintenance-cost rate for these eleven problems amounts to \$0.028 per 100 miles.

When the three problems with bell-mouth hitches are included, the total expense for coupling systems increases to \$861.59, or \$30.77 per unit. This results in a cost rate of \$0.047 per 100 miles for the maintenance of coupling systems.

#### *Electrical system*

For the purpose of this study, electrical system includes wires, lights, fuses, junction boxes, switches, connectors, and other miscellaneous electrical components. During the study, forty-five electrical system problems were reported. The total accumulated

<sup>58</sup> More precisely, this figure was 52.76 and the number of problems assigned to maintenance was 3.24, but we will refer only to round numbers in this section.

<sup>59</sup> This damage can be attributed to improper hitching procedure and related abuse of the hardware. As such it might arguably be considered a training problem as opposed to a maintenance problem.

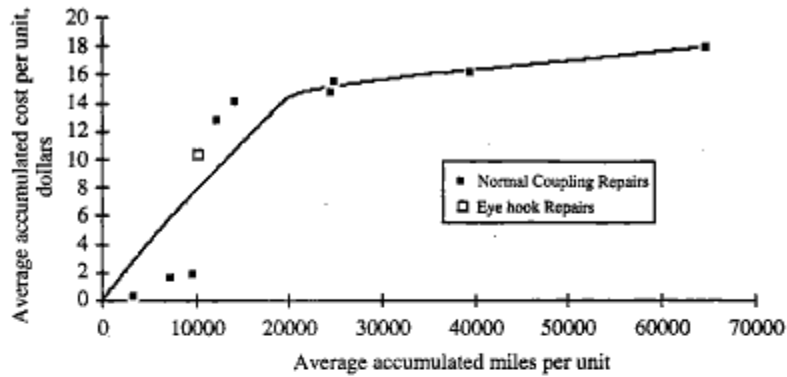

Figure 54. Average accumulated costs per unit for the coupling system of C-dollies

standardized cost of these problems, both parts and labor, was \$1,923.15 (\$68.68 per unit).

Figure 55 shows the accumulation of electrical system costs for an average C-dolly as a function of accumulated miles. Of the forty-five problems, eight involved repair of the tail light assembly, damaged when *stacking* dollies at the distribution terminals. Seventy-five percent of these accidents occurred at one fleet where the C-dollies tail light assemblies aligned exactly with the pintle-eyes of their other dollies. The total cost to repair these problems was \$382.25 (\$13.65 per unit).

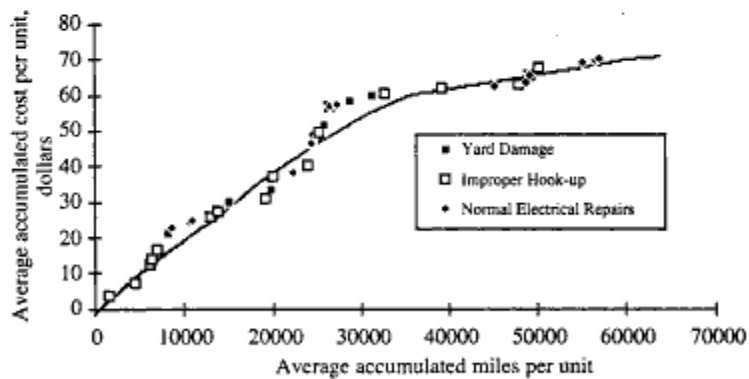

Figure 55. Average accumulated cost per unit for the maintenance of the electrical system of C-dollies

Fourteen (31 percent) of the forty-five electrical problems were considered typical electrical repairs and are denoted as "Normal Electrical Repairs" in figure 55. These repairs included replacing light bulbs, finding and correcting electrical shorts and replacing, cleaning, or rewiring seven-way connectors. The total cost to repair these problems was \$503 (17.96 per unit).

The remaining twenty-three problems were unique to the C-dolly and involved the seven-wire jumper cable of the dolly. When coupling dollies, if the two seven-wire cables attached to the dolly are of different length, drivers and hostlers are accustomed to attaching the longer cable to the leading trailer and the shorter one to the following trailer. This is logical with a conventional A-dolly because the range of motion between the dolly and the leading trailer is greater than between the dolly and following trailer. However, with the C-dolly, the opposite is true. The distance between the C-dolly and the lead trailer is basically fixed (with the exception of small pitch motions), while the distance between the C-dolly and following trailer will vary more than with a conventional A-dolly. This caused problems during the study because drivers and hostlers would follow their usual procedure and attach the shorter lead to the following trailer. This often resulted in the electrical junction box being damaged when the driver made a sharp, low-speed turn. The twenty-three problems of this type had a total cost of \$1,037.90, and they were distributed through all the Portland fleets.

The average CPCM for the electrical system maintenance on C-dollies for the entire study was \$0.106. This is greater than the \$0.072 CPCM found to represent the average electrical system maintenance cost for A-dollies. If the costs arising from the improper hook-up repairs are subtracted the CPCM for C-dollies drops to \$0.049.

#### *Frame system*

For the purpose of this study, the frame system includes the frame, dolly jack, suspension components, and axle. During the study, twenty-one frame problems were reported for the C-dolly fleet.<sup>60</sup> The total accumulated standardized cost of these problems, both parts and labor, was \$2,201.75 (\$78.63 per unit).

Figure 56 shows the accumulation of frame system costs for an average C-dolly as a function of accumulated miles. Of the twenty-one problems, eighteen (86 percent) involved repair or replacement of the dolly jack or one of its subassemblies. Two of the remaining three repairs were simple adjustments to the frame system and cost a total of only \$29.25. The third problem involved the repair of a broken weld on an axle at the left backing plate. (The axle supplier, KGI, said the problem was caused by a bad welding rod from one of

---

<sup>60</sup> Thirty reports of damage to the dolly jack leg at fleet X were excluded from this total. See the discussion on jack leg costs at fleet X presented earlier in this section.

their suppliers.) The cost for this repair was \$490, including parts, labor, and \$350 to rent welding equipment.

The average CPCM for maintenance of the frame system of C-dollies was \$0.131. This average is greater than the \$0.060 CPCM found to represent the average frame system costs for A-dollies.

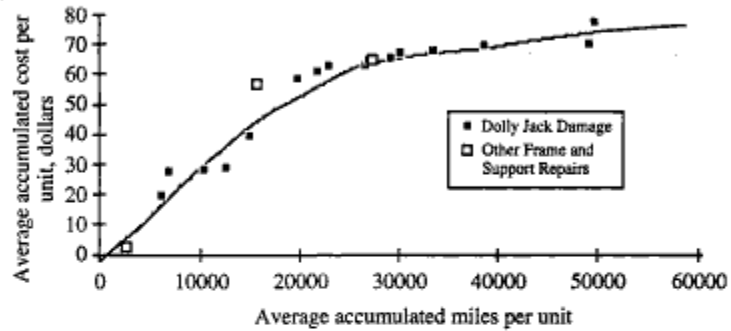

Figure 56. Average accumulated costs per unit for the frame system of C-dollies

#### Steering system

Steering-system costs are unique to the C-dolly. For the purpose of this study, the steering system includes the damper, valves, and all miscellaneous parts associated with the control of the self-steering action of the dolly wheels. During the study, twenty-one steering-system problems were reported. The total accumulated standardized cost of these problems was \$684.90 (\$24.46 per unit).

Figure 57 shows the accumulation of steering-system costs for an average C-dolly as a function of accumulated miles. Thirteen (62 percent) of the twenty-one problems were a result leaking air diaphragms within the steering damper assemblies. The average time of repair was 0.54 hours and the total cost of these repairs was \$368.80. ITR indicated that these problems were caused by a batch of defective diaphragms from their supplier.

There were six (29 percent) miscellaneous steering problems with a total cost of \$246.10. These problems included repairs to the air-damper mounting bracket, regulator valve, and axle lock valve. These repairs occurred at four different fleets.

There were two problems of wheel alignment during the study. They occurred on two different units at one fleet and were detected when very excessive tire wear was found during a periodic maintenance cycle. The realignments required one hour for each dolly and had a total cost of \$70.00.

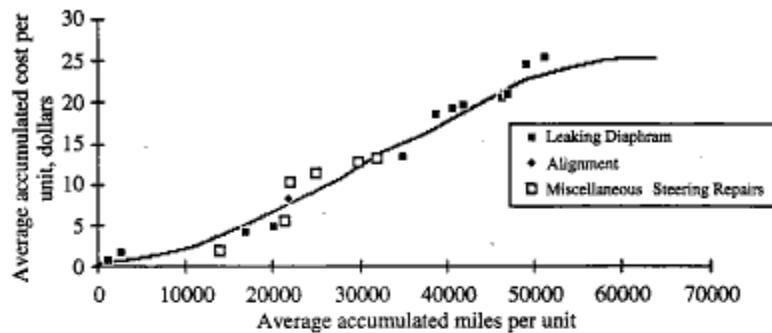

Figure 57. Average accumulated costs per unit for the steering system of C-dollies

The average CPCM related to the steering system for the entire study was \$0.038. This average is less than the \$0.072 CPCM for the steering system found in the historical C-dolly records.

#### *Trim System*

For the purpose of this study, the trim system includes items such as mud flaps, quarter fenders, chain hangers, brackets, etc. There were eleven repairs of the trim system during the study. The total accumulated standardized cost of these problems, both parts and labor, was \$556.75. On a per dolly basis, \$19.88 was spent on this system. A breakdown of these repairs follows: seven were to fix the mud flaps, three were for quarter fenders, and one was to straighten chain hangers. The CPCM for these repairs was \$0.031

#### *Wheels System*

The wheels system includes hubs, studs, wheel seals, bearings, etc. There were ten repairs made to the wheel systems during the study. The total accumulated standardized cost of these problems, both parts and labor, was \$562.25. On a per dolly basis, \$20.08 was spent on this system. A breakdown of these repairs follows: eight were to fix leaking seals, one was to replace a hub cap, and one was to top-off a low oil level in a hub. The CPCM for these repairs was \$0.031

#### **Maintenance Costs Experienced By C-Dollies Based On Historical Records**

Review of historical C-dolly records shows a \$0.381 CPCM for the seven dolly systems. These costs were derived from nearly 900 maintenance records gathered from the one fleet. The records reflect the cost to maintain twenty C-dollies between March 1989 and April 1993. These units accumulated a total of 3.8 million miles during this period. Generally, these results are consistent with those of other sources with the exception of the

ESTUDIO DE INVESTIGACIÓN DE LA UNIVERSIDAD DE MICHIGAN  
 Puede ser consultado en:

<http://www.hti.umich.edu/cgi/t/text/text-idx?sid=50cf84488b83cc2b8ba0554be1cc5c98;c=umtri;idno=88519.0001.001>

brake system costs. These data reflect a \$0.066 CPCM for brakes, which appears low relative to A-dolly results. A review of these records revealed very few brake system overhauls. This is unusual since the records from other fleets indicate that friction materials are replaced every 120,000 to 180,000 miles. If a more typical CPCM is used for the brake system costs (\$0.213), the total CPCM for the historical C-dollies increases to \$0.528 CPCM.

**Table 22. Summary of historical maintenance costs for C-dollies**

<i>System</i>	<i>Maintenance cost, dollars per 100 miles</i>
<i>Brakes</i>	0.066
<i>Coupling</i>	0.097
<i>Electrical</i>	0.046
<i>Frame</i>	0.064
<i>Steering</i>	0.071
<i>Trim</i>	0.014
<i>Wheels</i>	0.025
<i>Total</i>	0.381

**Maintenance Costs Incurred By A-Dollies In The Field Study**

In addition to tracking and collecting the maintenance data on twenty-eight C-dollies, a fleet of sixteen A-dollies was also monitored during the study. Table 23 shows how the A-dollies were distributed among four of the participating fleets. (The fifth fleet does not use A-dollies.) The sixteen A-dollies accumulated approximately one million miles during the study.

**Table 23. Mileages of A-dollies tracked in the field study**

<i>Fleet</i>	<i>Number of Dollies</i>	<i>Total Fleet Miles</i>	<i>Average Miles per Unit</i>
<i>A</i>	3	237,765	79,255
<i>B</i>	6	227,816	37,969
<i>C</i>	3	335,166	111,722
<i>D</i>	4	262,492	65,623
<i>Total</i>	16	1,063,239	66,452

Table 24 is a summary of the CPCM for these A-dollies. The operating costs for all systems of A-dollies (other than tires) ranged from \$0.385 to \$0.565 per 100 miles. The average CPCM of all the dollies observed was \$0.501.

**Table 24. Summary of the maintenance costs for the A-dollies of the study in dollars per 100 miles**

System	Individual fleet costs from least to most expensive in each category				All fleets pooled
Brakes	0.256	0.271	0.293	0.297	0.278
Coupling	0.011	0.060	0.061	0.068	0.052
Electrical	0.028	0.036	0.055	0.138	0.063
Frame	0.000	0.000	0.053	na <sup>†</sup>	0.019
Trim	0.012	0.021	0.03	0.081	0.037
Wheels	0.000	0.023	0.049	0.118	0.053
All systems <sup>††</sup>	0.385	0.478	0.535	0.565	0.501

<sup>†</sup> The CPCM for frame systems of fleet X is believed to be anomalous and is excluded from the calculation of the average.

<sup>††</sup> Not the total of the columns, but the values of the individual fleets ordered from least to most expensive.

#### Maintenance Costs Incurred By A-Dollies Based On Historical Records

A-dolly maintenance costs were derived from historical records retrieved from two fleets.<sup>61</sup> The maintenance records for eight A-dollies in one fleet for the period of October 1988 through November 1993 were collected and standardized. These units traveled a total of 2.6 million miles during this period and, on average, each dolly accumulated approximately 327,000 miles. The average CPCM was \$0.407.

The records of three dollies in a third fleet included sufficient mileage information to determine maintenance costs per mile. Records for these dollies were obtained for the period from January of 1988 through May of 1995. These units traveled a total of 1.5 million miles during this period and, on average, each dolly accumulated 0.5 million miles. These units had a total CPCM of \$0.505.

Table 25 is a summary of the CPCM for the historical maintenance records on A-dollies. The total CPCM for all eleven A-dollies taken as a group was \$0.492.

<sup>61</sup> These were the only two fleets with sufficient information to determine maintenance cost on a per mile basis.

**Table 25. Summary of historical maintenance costs for A-dollies in dollars per 100 miles**

System	Individual fleet costs		All fleets pooled
	Least expensive	Most expensive	
Brakes	0.165	0.216	0.197
Coupling	0.035	0.145	0.076
Electrical	0.071	0.076	0.074
Frame	0.079	na <sup>†</sup>	0.079
Trim	0.02	0.038	0.031
Wheels	0.026	0.043	0.036
All systems <sup>††</sup>	0.407	0.505	0.492

<sup>†</sup> The CPCM for frame systems of fleet X is believed to be anomalous and is excluded from the calculation of the average.

<sup>††</sup> Not the total of the columns, but the values of the individual fleets ordered from least to most expensive.

#### Maintenance Costs For A-Dollies From Other Sources

Additional data on the maintenance costs of A-dollies is shown in table 26 in comparison to the summary costs for A-dollies and C-dollies determined in this study. The new data are for an LTL fleet with approximately 4,000 dollies. They are the average of year-end costs for five of the six years from 1987 through 1992.<sup>62</sup> Despite the fact that these LTL values are not based on the standard labor rate (\$35 per hour) or parts costs used in this study, they are in general agreement with the representative costs found for A-dollies and C-dollies in this study.

These additional data are presented for reference only. Because of the different bases for costs, these figures are not used in any of the analyses presented in this chapter.

<sup>62</sup> These data were supplied by Robert Deierlien in private correspondence with UMTRI. Mr. Deierlien is a consultant to the trucking industry.



ESTUDIO DE INVESTIGACIÓN DE LA UNIVERSIDAD DE MICHIGAN

Puede ser consultado en:

<http://www.hti.umich.edu/cgi/t/text/text-idx?sid=50cf84488b83cc2b8ba0554be1cc5c98;c=umtri;idno=88519.0001.001>

**Table 26. Other maintenance costs for A-dollies,  
dollars per 100 miles**

<i>System</i>	<i>LTL Fleet Data</i>	<i>Field Study A-dollies</i>	<i>Field Study C-dollies</i>
<i>Brakes</i>	0.280	0.213	0.074
<i>Coupling</i>	0.022	0.071	0.081
<i>Electrical</i>	0.058	0.072	0.065
<i>Frame</i>	0.124	0.060	0.084
<i>Steering</i>	0.000	0.000	0.060
<i>Trim</i>	0.018	0.032	0.019
<i>Wheels</i>	0.033	0.040	0.027
<i>Total</i>	0.536	0.487	0.411

### THE OPINIONS OF FLEET PERSONNEL REGARDING C-DOLLIES IN LCV OPERATIONS

The drivers, mechanics, and fleet managers participating in the LCV field study were surveyed to determine their opinions on C-dollies. Five opinion surveys were conducted periodically throughout the field study so that the changes in opinion with exposure to C-dollies could be observed. The results of these surveys reveal that (1) the opinions of fleet personnel regarding C-dollies are generally positive, (2) drivers' opinions of C-dollies were strongly positive and consistently the most positive among the three classifications of fleet personnel, and (3) in general, opinions on C-dollies held fairly consistent over the period of the study.

The survey included prepared questions dealing with reliability, maintainability, and general usefulness of C-dollies. Participants responded to these questions according to a prepared rating scale. They were also encouraged to provide written comments and observations about their experience with, and views on, C-dollies. Survey forms, along with the complete set of survey results, are presented in appendix C.

The prepared questions on C-dollies, and the language of the respective response scales, were as follows:

- *How familiar are you with double-drawbar C-dollies?* Not familiar; somewhat familiar; very familiar.
- *How would you rate the reliability of C-dollies?* Not reliable; average reliability; very reliable.
- *Based on your experience with both A-dollies and C-dollies, have you found one to be more difficult to use (maintain)?*<sup>63</sup> C-dolly more difficult; both are the same; A-dolly more difficult.
- *What is your opinion of using C-dollies in double and triple combinations?* Strongly opposed; no opinion; strongly favor.
- *How do you feel the use of C-dollies will change your job?* Make it harder; no change; make it easier.

An average of thirty-two drivers, fourteen managers, and twenty-one mechanics responded to each of the five surveys. One hundred ninety-one drivers participated in the study, but many of these only took one or two trips with the field study vehicles. Only those drivers who used the equipment regularly were asked to complete questioners.

The summary results for each of these questions are presented in figure 58. Pooled results are presented for drivers, mechanics, and managers, respectively. The vertical scale

<sup>63</sup> Drivers and management were asked about use. Mechanics were asked about maintenance.

Puede ser consultado en:

<http://www.hti.umich.edu/cgi/t/text/text-idx?sid=50cf84488b83cc2b8ba0554be1cc5c98;c=umtri;idno=88519.0001.001>

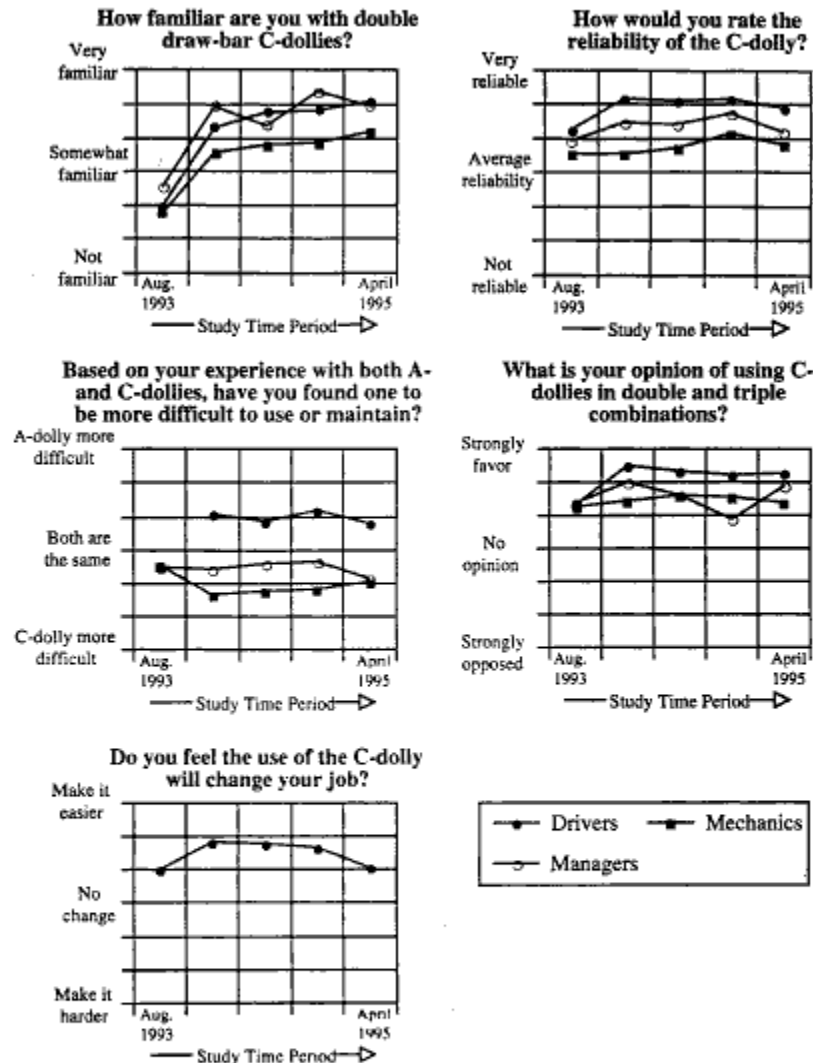

Figure 58. Opinions of fleet personnel on C-dollies in LCV operations

of the graph is arranged such that positive reactions to C-dollies are up and negative reactions are down. Results are presented for each of the five surveys, with time progressing from left to right.

There were fifty-four positive and thirty negative comments on C-dollies written in on the survey forms. (Occasionally one response contains both positive and negative comments.) The positive comments concentrated on safety and ease of driving. The negative comments related primarily to hitching and tire wear. All written comments appear in appendix C.

A discussion of results for each individual question follows. A sample of written comments related to the question is presented where available. Comments are identified with the personnel group and the data source (i.e., the number of the survey or the abbreviation DTF, for driver trip form), for example, [Driver, 3].

**Familiarity: How familiar are you with double-drawbar C-dollies?**

As could be expected, all three classes of fleet personnel showed a trend toward becoming *very familiar* with the C-dollies over the course of the study. Surprisingly, all three groups felt they were *somewhat familiar* with the C-dolly at the start of the study. Drivers had the most dramatic change from less than *somewhat familiar* to nearly *very familiar*.

**Reliability: How would you rate the reliability of C-dollies?**

All three groups of fleet personnel rated the reliability of C-dollies above average. The drivers gave the C-dolly its highest scores for reliability and consistently ranked the dolly as nearly *very reliable*. The mechanics gave the lowest scores but still consistently rated C-dollies as having better than *average reliability*. The opinion of the managers was between that of the drivers and mechanics, giving the C-dolly an above *average reliability* rating. In general, opinions on reliability stayed fairly constant over the course of the study. From the first to the fourth survey, there was a modest improvement in the opinions on reliability, but this was followed by a general decline in the last survey.

Over the 1.4 million trip miles that the twenty-eight C-dollies traveled during the study, there were two breakdowns on the road reported. One resulted when the driver was unable to unhook the dolly even after receiving instructions by phone. The second resulted from a brake system air leak that caused the brakes to lock up. The second problem was discussed in detail the chapter on C-dolly maintenance.

**Maintenance And Use: Based on your experience with both A-dollies and C-dollies, have you found one to be more difficult to use (maintain)?**

The third survey question asked fleet personnel about their opinions on whether an A-dolly or C-dolly is more difficult to use or maintain. The drivers and managers were asked

about dolly use. The mechanics were asked about maintenance. (This question was mistakenly left off the driver's evaluation form during the first survey period.)

This is the only survey question which elicited a negative response regarding C-dollies. Mechanics found the C-dolly to be more difficult to maintain than the A-dolly. This is not surprising since the C-dolly is more complicated, mostly due to its steering mechanism. Also, managers felt that C-dollies were more difficult to use than A-dollies, although their opinion here was nearly neutral.

In contrast, however, drivers felt C-dollies were easier to use. Even though drivers had difficulty with the C-dolly hitching mechanism and logged many coupling complaints, they saw the C-dolly as easier to use than the A-dolly. This result suggests that the benefits of better handling and tracking, and the ability to back-up the LCV when using C-dollies outweigh the negative aspect of the more difficult hitching mechanism.

None of these opinions was very strong, and there were no strong trends for change in these opinions over the course of the project.

*Written comments*

- C-dolly operation is much safer than A-dolly. [Driver, 2]
- The C-dollies are much (very much) an improvement in tractability in long combinations (triples). They also eliminate sway almost completely. I feel safer in snow or ice when pulling a set with a C-dolly than with an A-dolly. I would hope that, in the near future, these C-dollies will become universal converter gear used with all doubles and triple combinations. [Driver, 2]
- Noticed difference between A-dollies and C-dollies in the first mile of freeway driving. C-dollies pull straight as a pin—can't get them to sway without really trying. The C-dolly cornering at road speed is much improved over A dollies. First impression—They're a pleasure to pull. [Driver, DTF]
- Snow was rough and rutted. Trailers pulled very well, back box didn't flop around and try to pull the rest of the set out of line like with A-dollies. [Driver, DTF]
- The C-dolly. I've heard from most drivers they like it better than a regular dolly. The trailers change lanes better and without the whipping you get from a regular dolly. From a service point of view, the C-dolly is not much harder than the A-dolly. As a mechanic and shop foreman I am impressed with the operation of both ABS and the C-dolly. [Mechanic, 2]
- C-Dollies hard to hook up and seem to get damaged during hook/unhook more than A-dollies. Drivers and yard hostlers say it takes twice as long to hook triples with C-dollies. [Manager, 2]
- The C-dolly hitches require training in addition to regular single hitches. They can easily frustrate an unfamiliar driver. [Mechanic, 2]

- The C-dollies seem to have been rough on tires & the hitches could use some release improvements. [Mechanic, 5]
- C-dollies seem to be more stable but harder to maintain and more difficult to use. [Manager, 4]

**C-dolly Use: What is your opinion of using C-dollies in double and triple combinations?**

All three classifications of fleet personnel were in favor of using C-dollies. The drivers held the strongest opinion in this regard. This result is not surprising since it is the drivers who benefit the most from the positive qualities of the C-dolly. Management's view on this question fluctuated during the study, but always remained favorable. The mechanics consistently had a favorable view of C-dolly use in LCV operations. Again, there were no strong trends toward changing opinions over the course of the study.

*Written comments*

- From what I have seen I am impressed with both (C-dollies and ABS). [Mechanic, 5]
- In my opinion the C-dolly is the best thing made for safety of pulling combinations. [Driver, 1]
- C-dollies should be mandatory. [Driver, 5]
- A-dollies should be outlawed! [Driver, 5]
- C-dolly hitches still hard to unlock. C-dollies not suited for this company's type of work. [Mechanic, 3]
- Both types of equipment will improve the safety and handling of doubles and triples. [Manager, 3]
- After learning how the C-dolly works, its the best way to go! Back trailers are a lot more stable in wind, on rutted roads, etc. [Driver, 1]
- I feel the C-dolly should be law to pull triples and doubles. (LCVs) would be a lot safer. I have had several compliments pulling doubles and triples down the road on how straight they are pulling! [Driver, 3]
- The C-dolly equipment is great. I have never driven anything that handled that good in my life! [Driver, 3]

**Overall Influence: How do you feel the use of C-dollies will change your job?**

This question was only addressed to drivers, and was intended to assess whether drivers viewed C-dollies, overall, as a burden or an aid in their jobs.

Despite the additional burden of a more complicated and sometimes difficult hitching mechanism, the drivers consistently indicated that, overall, the C-dolly did make their job

*easier*. This rating rose early in the study and then fell again at the end. However, it always remained distinctly positive.

*Written comments*

- After using a C-dolly for so long, going back to the A-dolly is like going from the space shuttle to a horse and buggy. It takes longer to do my work; more hooking and unhooking, switching trailers around. Going down the road there is a considerably more rear trailer sway. Also, I believe that when the rear trailer sways and moves the dolly, it also allows the front trailer to move more. The C-dolly provides stability to both front and rear trailers. [Driver, DTF]
- The C-dolly made for the most stable combination of trailers that I have ever pulled. I was highly impressed with the way the trailers handled. It also made it very easy to maneuver when backing into a dock. [Driver, DTF]
- Liked the way they pulled down the road. First trip with C-dolly made job a little slow because of hook-up, but can see no real change in job or time with more trips. [Driver, 3]
- My third trailer was to be left at Springfield. I was able, because of the C-dollies, to back all three trailers into the dock and disconnect as usual, leaving the dolly under the trailer. I have been able to save a considerable amount of time using the C-dolly. [Driver, DTF]

### SUMMARY OF OPINIONS ON C-DOLLIES

In general the response of the personnel of the participating fleets to C-dollies was very positive. Table 27 shows a summary of the opinion results for each question. The table shows the percentage of each group (drivers, mechanics, management) who rated the C-dolly positively in response to the individual questions.<sup>64</sup> All of the categories except two show a strong bias toward positive response. In the two exceptional cases, managers rate C-dollies more difficult to use than A-dollies and mechanics rate C-dollies more difficult to maintain.

---

<sup>64</sup> A positive response is a response above 4 on the 7-point rating scale used for each question. This scale is represented by the seven lines of the verticle grid of figure 58.

**Table 27. Positive ratings of C-dollies by fleet personnel**

<i>Survey questions</i>	<i>Percent positive responses</i>		
	<i>Drivers</i>	<i>Mgt.</i>	<i>Mech.</i>
<i>How familiar are you with double-drawbar C-dollies? Not familiar; somewhat familiar; very familiar.</i>	75	88	71
<i>How would you rate the reliability of C-dollies? Not reliable; average reliability; very reliable.</i>	100	96	83
<i>Based on your experience with both A-dollies and C-dollies, have you found one to be more difficult to use (or maintain)? C-dolly more difficult; both are the same; A-dolly more difficult.</i>	74	29	13
<i>What is your opinion of using C-dollies in double and triple combinations? Strongly opposed; no opinion; strongly favor.</i>	100	92	100
<i>How do you feel the use of C-dollies will change your job? Make it harder; no change; make it easier.</i>	83	N/A	N/A



## REFERENCES

1. Winkler C.B., Bogard S., Bowen, M.A. *Heavy truck crash avoidance research support; vehicle dynamics—project 1—planning to conduct LCV operational test*. Transportation Research Institute, University of Michigan. UMTRI-93-9. Ann Arbor, Michigan. February, 1993.
2. Klusmeyer, L.F., et al. *An in-service evaluation of the reliability, maintainability, and durability of antilock braking systems (ABS) for heavy truck tractors*. Southwest Research Institute. Report number 03-2467. San Antonio. March, 1992.
3. Klusmeyer, L.F., et al. *An in-service evaluation of the reliability, maintainability, and durability of antilock braking systems (ABS) for semitrailers*. Southwest Research Institute. Report number 03-2467. San Antonio. October, 1993.
4. Society of Automotive Engineers. "Seven conductor electrical connector for tractor-trailer jumper cables." *SAE J1560.1995 SAE Handbook*. Vol. 2. Society of Automotive Engineers. Warrendale, Pennsylvania. 1995. Pp 23.191.
5. Society of Automotive Engineers. "Seven conductor jacketed cable for truck trailer connections." *SAE J1067.1995 SAE Handbook*. Vol. 2. Society of Automotive Engineers. Warrendale, Pennsylvania. 1995. Pp 23.196.
6. Society of Automotive Engineers. "Coiled electrical cables." *SAE J2222.1995 SAE Handbook*. Vol. 2. Society of Automotive Engineers. Warrendale, Pennsylvania. 1995. Pp 23.194.
7. Truck Trailer Manufacturers Association. "TTMA recommended practice number 14-84." Truck Trailer Manufacturers Association. Alexandria, Virginia. August, 1984.
8. Society of Automotive Engineers. "Brake and electrical connection locations—truck-tractor and truck-trailer." *SAE J702.1995 SAE Handbook*. Vol. 3. Society of Automotive Engineers. Warrendale, Pennsylvania. 1995. Pp 36.121.
9. Society of Automotive Engineers. "Trailer tow bar eye and pintle hook/coupler performance." *SAE J847.1995 SAE Handbook*. Vol. 3. Society of Automotive Engineers. Warrendale, Pennsylvania. 1995. Pp 36.102.
10. *Motor vehicle safety test methods*. Section 903—C-dolly. Transport Canada. Road Safety. TP 3666. Ottawa, Ontario. June, 1991.
11. Woodrooffe, J.H.F., LeBlanc, P.A., El-Gindy, M., *Technical analysis and recommended practice for the double-drawbar dolly using self-steering axles*. National Research Council of Canada, Division of Mechanical Engineering. Technical Report. Project No. 1376. Ottawa, Ontario. 1990.
12. *Truck and bus accident factbook 1992*. Center for National Truck Statistics, Transportation Research Institute, University of Michigan. UMTRI-94-44. Ann Arbor, Michigan. December, 1994.

## ESTUDIO DE INVESTIGACIÓN DE LA UNIVERSIDAD DE MICHIGAN

Puede ser consultado en:

<http://www.hti.umich.edu/cgi/t/text/text-idx?sid=50cf84488b83cc2b8ba0554be1cc5c98;c=umtri;idno=88519.0001.001>

13. Blower, D., Lyles, R., Campbell, K., Stamatiadis, P. *The Michigan heavy truck study*. Transportation Research Institute, University of Michigan and State University Department of Civil and Environmental Engineering. UMTRI-90-1-1. Ann Arbor, Michigan. April, 1990.
14. Jindra, F. "Lateral oscillations of trailer trains." *Ingenieur-Archiv*, Vol 33, 1964. Pp 190-204.
15. Hazemoto, T. *Analysis of lateral stability for doubles*. Presented at the Society of Automotive Engineers, Combined Commercial Vehicle Engineering and Operations and Powerplant Meetings, 18-22 June 1973, Chicago, Ill. Report No. SAE 730688. 1973.
16. Hales, F.D. "The rigid body dynamics of road vehicle trains." *The Dynamics of Vehicles on Roads and on Railway Tracks. Proceedings*. Amsterdam, Swets and Zeitlinger, 1976. Pp. 131-151.
17. Nordmark, S., Nordstrom, O. "Lane change dynamics versus geometric design of truck and full trailer combinations." FISITA. International Congress. XVIIIth. Volume II. Budapest. OMKDK, Technoinform. 1978. Pp. 1737-1747.
18. Mallikarjunarao, C., Segel, L. "A study of the directional and roll dynamics of multiple-articulated vehicles." *The Dynamics of Vehicles on Roads and on Tracks. Proceedings*. Lisse, Swets and Zeitlinger. 1982. Pp. 81-96.
19. Ervin, R.D., et. al. *Ad hoc study of certain safety-related aspects of double-bottom tankers*. Highway Safety Research Institute, University of Michigan. Ann Arbor, Michigan. Report No. UM-HSRI-78-12-2. 1978.
20. Winkler, C.B., et al. *Improving the dynamic performance of multitrailer vehicles: a study of innovative dollies*. Transportation Research Institute, University of Michigan. Ann Arbor, Michigan. Report No. UMTRI-86-26, July, 1986.
21. Fancher, P.S. "The static stability of articulated commercial vehicles." *Vehicle System Dynamics*, Vol. 14, No. 4-6. June 1985. Pp. 201-227.
22. Winkler, C.B., et al. *Evaluation of innovative converter dollies*. Transportation Research Institute, University of Michigan. Ann Arbor, Michigan. Report No. UMTRI-93-47, December, 1993.
23. Aurell, J., Winkler, C.B. "Standard test procedures for the lateral stability of heavy vehicle combinations." *Road Transport Technology—4*. Proceedings of the Fourth International Symposium on Heavy Vehicle Weights and Dimensions. Transportation Research Institute, University of Michigan. Ann Arbor, Michigan. June 1995. Pp. 463-472.
24. Society of Automotive Engineers. "A test for evaluating the rearward amplification of multi-articulated vehicles." SAE J2179. *1995 SAE Handbook*. Vol. 3. Society of Automotive Engineers. Warrendale, Pennsylvania. 1995. Pp 36.68.
25. International Standards Organization. "Road vehicles—heavy commercial vehicles combinations and articulated buses—lateral stability test procedure." International

ESTUDIO DE INVESTIGACIÓN DE LA UNIVERSIDAD DE MICHIGAN

Puede ser consultado en:

<http://www.hti.umich.edu/cgi/t/text/text-idx?sid=50cf84488b83cc2b8ba0554be1cc5c98;c=umtri;idno=88519.0001.001>

Standards Organization. ISO TC22/SC9/WG6/N17. (A working document. Publication as a proposed standard expected in 1996.)

26. Skeydel, S. "Leading common carrier report." *Diesel Equipment Superintendent (DES)*. Business Journals, Inc. Norwalk, Connecticut. June, 1991. Pp 40.
27. Kennedy, T. "Lease, spec and maintenance." *Go West*. Motor Transport Publishers, Inc. Gold River, California. March, 1993. Pp 18.

ESTUDIO DE INVESTIGACIÓN DE LA UNIVERSIDAD DE MICHIGAN  
Puede ser consultado en:  
<http://www.hti.umich.edu/cgi/t/text/text-idx?sid=50cf84488b83cc2b8ba0554be1cc5c98;c=umtri;idno=88519.0001.001>

UMTRI-86-26/1

AUG - 4 1986

74411

**Improving the Dynamic Performance of  
Multitrailer Vehicles:  
A Study of Innovative Dollies**

**Volume I  
Final Technical Report**

**C. B. Winkler  
P. S. Fancher  
O. Carsten  
A. Mathew  
P. Dill**

**July 1986**

**UMTRI** The University of Michigan  
Transportation Research Institute

ESTUDIO DE INVESTIGACIÓN DE LA UNIVERSIDAD DE MICHIGAN  
Puede ser consultado en:

<http://www.hti.umich.edu/cgi/t/text/text-idx?sid=50cf84488b83cc2b8ba0554be1cc5c98;c=umtri;idno=88519.0001.001>

TABLE OF CONTENTS

VOLUME I: FINAL TECHNICAL REPORT

<u>Section</u>	<u>Page</u>
INTRODUCTION.....	1
A REVIEW OF INNOVATIVE DOLLIES AND COUPLING MECHANISMS .....	5
1. Modified A-Dollies .....	8
2. B-Dollies .....	25
THE SIMULATION STUDY.....	32
1. The "Test" Vehicle .....	32
2. Findings with Respect to the Use of Innovative Coupling Mechanisms .....	33
3. Findings with Respect to the Use of Mixed-Width Axles .....	121
THE VEHICLE TEST PROGRAM .....	129
1. Test Dollies .....	133
2. Test Program Findings .....	149
OPERATIONAL IMPACTS .....	183
1. Accident Studies .....	183
2. Economic Analysis .....	204
CONCLUSIONS AND RECOMMENDATIONS .....	228
1. Dolly Performance and Design Guidelines .....	228
2. Further Development of Innovative Dollies .....	232
REFERENCES.....	234

VOLUME II: APPENDICES

<u>Section</u>	<u>Page</u>
APPENDIX A: EXAMPLE LISTINGS OF SIMULATED VEHICLE PARAMETERS FOR THE YAW/ROLL SIMULATION.....	1
APPENDIX B: LISTINGS OF EQUATIONS AND VARIABLES USED IN THE FINANCIAL MODEL.....	39

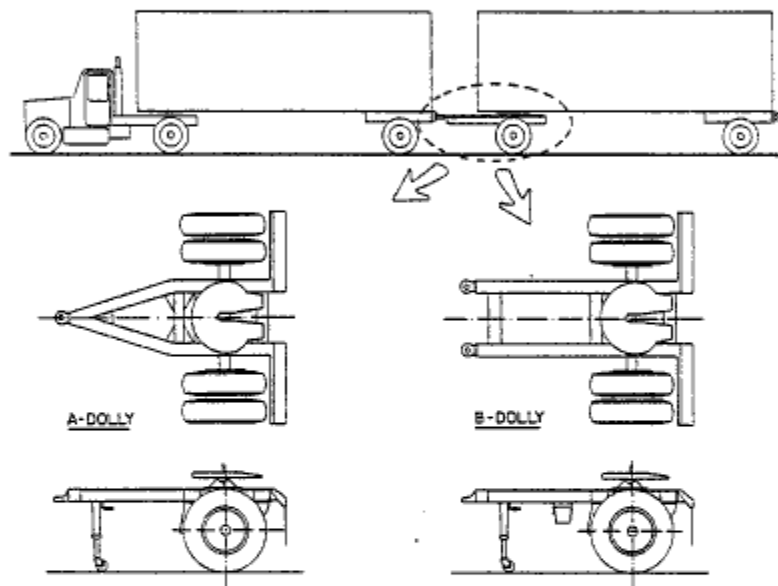

Figure 2. The A-dolly and B-dolly.

## CONCLUSIONS AND RECOMMENDATIONS

### 1. Dolly Performance and Design Guidelines

The results of the simulation study, and generally supported by the vehicle test program, suggest that it is both reasonable and practical to develop commercial vehicle dollies which can significantly improve the dynamic performance of the multitrailer combination vehicle. Accordingly, a set of reasonable performance and design "guidelines" can be enumerated which define goals for the development of innovative commercial vehicle dollies. The guidelines set forth below apply specifically to the vehicle configuration commonly known as the Western double, in the fully loaded, 80,000-lb (36,320-kg) gvw condition with both trailers having sprung mass c.g. heights of 80 in (2 m) (typical of "medium density" freight). The reference vehicle is shown in figure 19 of this report. Performance expectations would be different for other configurations. In that regard, current understanding suggests that caution should be exercised in applying B-dollies in long-drawbar configurations.

*Guidelines for Vehicle Dynamics Performance Properties.* Results of the simulation study indicate that innovative dolly designs can achieve substantial improvements in rearward amplification and dynamic rollover threshold without degrading other performance qualities of multitrailer vehicles. The following represent reasonable and practical vehicle performance goals which have been shown to be attainable for the Western double with several innovative dolly types:

- A maximum rearward amplification of less than 1.75 over the usable range of maneuvering frequencies (0 to 4 rad/sec)
- A dynamic rollover threshold (measured by peak lateral acceleration of the tractor in sine-steer maneuvers) of 0.3 g. or greater, over the usable range of maneuvering frequencies
- A minimum effective damping ratio of 0.25 or greater (as determined from the lateral acceleration response of the second trailer in a pulse-steer maneuver)
- A low-speed offtracking performance equal to or improved over that of the Western double equipped with an A-dolly.

*Guidelines for Dolly Mechanical Properties.* The simulation study indicates that there are several design approaches which can achieve some or all of the above performance goals. These properties are associated with the yaw and roll articulations of the dolly with respect to the first trailer. The general mechanical qualities of merit are as follows:

- 1) elimination or alteration of the yaw articulation behavior of the dolly relative to the first trailer (for improving rearward amplification performance) by means of one of the following methods:

- shifting of the dolly steer point substantially forward (at least 100 in (3 m) forward of the typical pintle position) during travel at highway speeds (above approximately 30 mi/h (48 km/h)) through the application of special hitching hardware or appropriately steering the dolly axle as a function of drawbar/articulation angle. To prevent degradation of low-speed offtracking, the steer point may be shifted rearward to the vicinity of the pintle during low-speed maneuvering.
- providing a mechanism to link the yaw articulation behaviors of the dolly relative to the first trailer and of the dolly relative to the second trailer, thus eliminating one yaw degree of freedom from the vehicle. A mechanism which provides approximately the articulation angle linkage gain of:

$$G_{\Gamma_2\Gamma_3} = \frac{OH + TL}{WB} \quad (17)$$

(see figure 44) is desirable since it provides "Ackerman steering" at low speed and good dynamic performance at high speed.

- eliminating the yaw degree of freedom between the dolly and first trailer, typically through the use of a rigid, double drawbar on the dolly of the B-dolly configuration. To prevent unacceptably high levels of tire scuffing and structural stress in low-speed maneuvering, this may be accompanied by the introduction of "controlled steering" or "self-steering" of the dolly tires. A controlled steering mechanism providing for steering of the dolly tires as a function of the articulation angle between the dolly and the second trailer is desirable. A mechanism which provides approximately the following steering gain (see figure 45) is appropriate since this gain provides for "Ackerman steering" at low speed and good dynamic performance at high speed:

$$G_{\delta_4\Gamma_3} = \frac{OH + TL}{WB + OH + LT} \quad (18)$$



Self-steering mechanisms require "centering spring" devices (or steering lock) which effectively prevent steering of the dolly wheels in dynamic highway maneuvers. This project has not specifically identified the level of steering resistance required to establish good performance, but a device which prevented steering at lateral tire friction utilization levels of approximately 0.3 was found to provide very good dynamic performance.

- 2) Connection of the first and second trailers in roll, typically through the use of rigid, double drawbars of the B-dolly configuration. This action proves to be very powerful in improving dynamic rollover threshold directly. It may also be moderately effective in reducing rearward amplification, depending on the properties of the tires installed on the vehicle. The level of rigidity attained in this coupling is critical in determining its effectiveness. A minimum stiffness of 30,000 in-lb (3,390 N-m) per degree of relative roll is desirable.

*Guidelines for Worst-Case Static Loading.* These guidelines are significant only to dollies of the linked-articulation and B-dolly configurations. These dollies provide new constraints in yaw and/or roll between the dolly and first trailer, thereby introducing significant new loads at the coupling between the dolly and first trailer. (Dollies which effectively relocate or alter the conventional single-point pintle, do not substantially alter hitch loadings.) These loadings, particularly in response to roll, are highly dependent on the rigidity of the dolly structures and the trailer structures, and this study examined a very limited sample in this regard. The simulation study assumed roll stiffness of the B-dolly drawbar coupling of 30,000 in-lb/deg (3,390 N-m/deg), and otherwise effectively rigid dolly and trailer structures. Accordingly, the results from the simulation are expected to be conservative. All the simulation results are from extreme lane-change maneuvers at the rollover threshold of the second trailer. The physical testing employed conventional van trailers, a linked-articulation dolly mechanism with unknown, but certainly significant, compliance, and B-dollies with unknown yaw compliance, but with approximately  $\pm 2.5$  degrees of roll-coupling lash. Vehicles of differing structural quality could be expected to yield different results. Maximum structural loads in the physical testing all came during low-speed maneuvers specifically designed to stress the couplings.

The worst-case loadings derived from the results of this study are listed in table 41. These values of forces and moments are intended to serve as first-order estimates for guiding the design of innovative dollies.

(The large difference between test measurements and simulation results for  $M_x$  is due to a special stress relieving feature of the test dolly. See the discussion presented in

ESTUDIO DE INVESTIGACIÓN DE LA UNIVERSIDAD DE MICHIGAN

Puede ser consultado en:

<http://www.hti.umich.edu/cgi/t/text/text-idx?sid=50cf84488b83cc2b8ba0554be1cc5c98;c=umtri;idno=88519.0001.001>

Table 41. Worst-Case Loading Values

Dolly Type	Fy, lb		Mx, in-lb		Mz, in-lb	
	Lateral Force	Simulation	Roll Moment	Simulation	Yaw Moment	Simulation
Linked-Articulation Dollies	4,014	5,800	N.A.	N.A.	253,900	305,600
B-Dollies (SA-60 or PRO)	8,660	6,256	672,400	243,300	659,800	688,900

I lb = 4,448 N  
I in-lb = 0.113 N-m

connection with table 17. If this stress relieving feature is not included in the design of the dolly, the simulation results provide a first-order estimate of the maximum roll moment.)

Low-speed maneuvering tests that can be performed in a large parking area can be used to introduce these forces and moments into prototype versions of new designs. Repeated applications of these forces and moments could be used to investigate structural fatigue. However, this would not rule out the possibility of other types of fatigue failure.

## 2. Further Development of Innovative Dollies

The findings of this study indicate that B-dollies are dynamically superior to A-dollies and other types of innovative dollies because of (a) the roll coupling between the leading semitrailer and the dolly, and (b) the possibility of steering the dolly wheels to achieve good trailing fidelity of the last trailer. However, estimates from accident analyses indicate that the safety benefits obtained by employing B-dollies result in a reduction of operating costs of only 0.84 cents per dolly per mile (1.6 km) (due primarily to an anticipated reduction in the number of rollover accidents). This reduction in operating costs due to accident prevention is not predicted to offset other increased costs associated with B-dollies. As long as productivity is the ruling force, there is not much *economic* incentive to use heavier B-dollies in place of lighter, simpler A-dollies.

The permit system that exists in the Western Provinces of Canada encourages the use of B-dollies there. Weight allowances and the right to operate on secondary roads are strong economic incentives that promote the use of B-dollies in Canada. The ability to back up and make local deliveries means that the operation of doubles with B-dollies can be very attractive and profitable in certain types of service. In order for B-dollies to become popular in the United States, economic incentives may need to be developed. These incentives might come from (a) reduction, through design or special permission, of the weight penalty associated with B-dollies, (b) extraordinarily unfavorable changes in insurance rates and/or increases in settlements from law suits, thereby increasing the economic importance of safety, or (c) allowance to travel off of the interstate and primary highway system to make deliveries and pick ups.

This study has demonstrated that innovative dollies can improve the dynamic performance of multi-trailer combination vehicles. In addition, fleet owners in Canada indicate that their drivers have greater confidence in the dynamic performance of doubles equipped with B-dollies. Nevertheless, several technical matters have not been studied enough to provide a comprehensive engineering understanding of the phenomena involved.

With regard to the mechanics of combination vehicles employing innovative dollies, the following subjects warrant further investigation:

- the sensitivity of dynamic rollover to the frequency response properties of the roll motions of doubles
- the influences of "dolly steering" rules on trailing fidelity (rearward amplification versus offtracking)
- the fatigue of dolly and trailer structures due to long-term use in normal service.

In the area of accident studies, more information is needed on the operation of doubles--specifically, data on accident costs, accident types (rollovers of the rear trailer only, for example), and exposure (what types of multi-trailer combinations are operated by what types of drivers on what types of roads).

The findings of this study are positive enough with respect to B-dollies to support a recommendation that combinations with new types of dollies be tested and evaluated in practical service in the United States. This evaluation effort would be in addition to a field trial of the prototype dolly that is currently underway in Canada. The evaluation efforts should include an investigation of the time savings, and thereby cost savings, that can be achieved through the ability to back up doubles equipped with B-dollies.

ESTUDIO DE INVESTIGACIÓN DE LA UNIVERSIDAD DE MICHIGAN  
Puede ser consultado en:  
<http://www.hti.umich.edu/cgi/t/text/text-idx?sid=50cf84488b83cc2b8ba0554be1cc5c98;c=umtri;idno=88519.0001.001>

# Evaluation of Innovative Converter Dollies:

Volume I  
Final Technical Report

Contract No. DTFH61-89-C-00081

Submitted to:  
U.S. Department of Transportation  
Federal Highway Administration

By:  
The University of Michigan  
Transportation Research Institute

2901 Baxter Road  
Ann Arbor, Michigan 48109-2150

December 1993

ESTUDIO DE INVESTIGACIÓN DE LA UNIVERSIDAD DE MICHIGAN

Puede ser consultado en:

<http://www.hti.umich.edu/cgi/t/text/text-idx?sid=50cf84488b83cc2b8ba0554be1cc5c98;c=umtri;idno=88519.0001.001>

**TABLE OF CONTENTS**

**VOLUME I: FINAL TECHNICAL REPORT**

<b>TABLE OF CONTENTS</b> .....	iii
<b>LIST OF FIGURES</b> .....	ix
<b>LIST OF TABLES</b> .....	xxiii
<b>INTRODUCTION</b> .....	1
<b>PRESENTATION OF THE STUDY METHOD AND RESULTS</b> .....	5
<b>VEHICLE PERFORMANCE MEASURES</b> .....	6
Static Roll Stability .....	6
Rearward Amplification .....	7
Dynamic Roll Stability .....	9
High-Speed Transient Offtracking .....	10
Yaw Damping .....	11
Low-Speed Offtracking .....	11
High-Speed Steady-State Offtracking .....	12
<b>DOLLY PROPERTIES AND CHARACTERISTICS</b> .....	13
Tongue Length .....	14
Overall Track Width .....	14
Hitch Position—Height .....	14
Hitch Position—Lateral Spacing .....	14
Effective Roll Compliance .....	15
Hitch and Frame Strength .....	15
Trailer-to-Trailer Roll Stiffness .....	15
Tire-Cornering Compliance .....	16
Suspension Roll Steer Coefficient .....	16
Dolly-Steering System Characteristic .....	16
<i>The Self-Steering C-Dolly</i> .....	16
<i>The Controlled-Steering C-Dolly</i> .....	17
Weight .....	18
<b>ELEMENTS OF THE SIMULATION STUDY</b> .....	18
Baseline Configurations .....	18
Parameter Variations .....	20
<i>Loading Condition</i> .....	20
<i>Hitch Location</i> .....	21
<i>Tires</i> .....	21
<i>Tongue Length</i> .....	21
<i>Suspensions</i> .....	22
The Dollies .....	22
Test Maneuvers .....	23
Computer Simulation Matrix .....	24
<i>Mapping the Primary and Secondary Performance Measures of A-</i> <i>trains</i> .....	25

ESTUDIO DE INVESTIGACIÓN DE LA UNIVERSIDAD DE MICHIGAN

Puede ser consultado en:

<http://www.hti.umich.edu/cgi/t/text/text-idx?sid=50cf84488b83cc2b8ba0554be1cc5c98;c=umtri;idno=88519.0001.001>

<i>Mapping the Primary and Secondary Performance Measures of C-trains</i> .....	25
<b>Filenames</b> .....	26
<b>Special Task—Stability in Backing</b> .....	26
<b>Parametric Sensitivities of Combination Vehicles</b> .....	27
<b>GENERALIZED ASSESSMENTS OF VEHICLE PERFORMANCE</b> .....	31
<b>Simplified Predictors of the Performance of A-trains</b> .....	32
<i>Limitations of the Predictive Models</i> .....	41
<i>Estimating Rearward Amplification</i> .....	42
<i>Estimating High-Speed Transient Offtracking</i> .....	43
<i>Estimating Static Rollover Threshold</i> .....	43
<i>Estimating Dynamic-Load-Transfer-Ratio (DLTR)</i> .....	44
<i>Estimating Damping Ratios</i> .....	45
<i>Estimating Low-Speed Offtracking</i> .....	45
<i>Estimating High-Speed Steady-State Offtracking</i> .....	46
<b>Performance Contrasts, C- versus A-trains</b> .....	46
<i>Summary</i> .....	51
<b>Ancillary Performance Issues</b> .....	53
<i>The Stability of A- and C-Trains While Backing</i> .....	53
<i>Loading Demands Placed on C-Dollies and Hitching Hardware</i> .....	59
<b>ECONOMIC ANALYSIS</b> .....	62
<b>Accident Reduction Benefits Due to Innovative Dollies</b> .....	62
<b>Costs to Be Borne from the Purchase, Maintenance, and Operation of Innovative Dollies</b> .....	66
<b>SUMMARY OF THE RESEARCH FINDINGS AND CONCLUSIONS PERTAINING TO DOLLY SPECIFICATIONS</b> .....	69
<b>SUMMARY AND DISCUSSION OF THE RESEARCH FINDINGS</b> .....	69
<b>CONCLUSIONS PERTAINING TO DOLLY SPECIFICATIONS</b> .....	71
<b>A-train Performance Problems</b> .....	72
<b>Basic Distinction Among Dolly Configurations</b> .....	72
<b>One Critical Dolly Specification</b> .....	73
<b>Other Significant Dolly Properties</b> .....	74
<i>Torsional Stiffness of the Dolly, as a Trailer-to-Trailer Link</i> .....	74
<i>Tongue Length</i> .....	76
<i>Strength Specifications</i> .....	76
<b>Specifications for Hardware Compatibility</b> .....	78
<b>REFERENCES</b> .....	81
<b>VOLUME II: APPENDICES</b>	
<b>TABLE OF CONTENTS</b> .....	iii
<b>LIST OF FIGURES</b> .....	vii
<b>LIST OF TABLES</b> .....	ix
<b>APPENDIX A: VEHICLE PERFORMANCE MEASURES</b> .....	1
<b>STATIC ROLLOVER STABILITY</b> .....	2

ESTUDIO DE INVESTIGACIÓN DE LA UNIVERSIDAD DE MICHIGAN  
Puede ser consultado en:

<http://www.hti.umich.edu/cgi/t/text/text-idx?sid=50cf84488b83cc2b8ba0554be1cc5c98;c=umtri;idno=88519.0001.001>

REARWARD AMPLIFICATION.....	8
YAW DAMPING (AS MEASURED WITH THE RTAC-B AND PULSE-STEER MANEUVERS).....	9
APPENDIX B: DOLLY PARAMETERS AND CHARACTERISTIC .....	13
TONGUE LENGTH.....	15
OVERALL TRACK WIDTH.....	15
HITCH POSITION—HEIGHT.....	15
HITCH POSITION—LATERAL SPACING.....	16
EFFECTIVE ROLL COMPLIANCE.....	16
HITCH AND FRAME STRENGTH.....	17
TRAILER-TO-TRAILER ROLL STIFFNESS.....	18
TIRE-CORNERING COMPLIANCE.....	19
SUSPENSION ROLL STEER COEFFICIENT.....	19
STEERING SYSTEM SPECIFICATIONS.....	19
Option 1—Self-steering.....	19
Option 2 — Controlled-steering.....	20
WEIGHT.....	22
COUPLING TIME.....	22
BACKING ABILITY.....	22
APPENDIX C: PARAMETRIC SENSITIVITY PLOTS.....	25
SENSITIVITY STUDY RESULTS FOR THE A-DOLLY.....	26
Sensitivity Plots of Static Rollover Threshold.....	28
Sensitivity Plots of High-Speed Steady-State Offtracking.....	32
Sensitivity Plots of Rearward Amplification.....	36
Sensitivity Plots of Dynamic-Load-Transfer Ratio.....	40
Sensitivity Plots of Transient High-Speed Offtracking.....	44
Sensitivity Plots of Damping Ratio in the RTAC-B Maneuver.....	48
Sensitivity Plots of Damping Ratio in the Pulse-Steer Maneuver.....	52
SENSITIVITY STUDY RESULTS FOR THE 2C1-DOLLY.....	56
Sensitivity Plots of Static Rollover Threshold.....	57
Sensitivity Plots of High-Speed Steady-State Offtracking.....	60
Sensitivity Plots of Rearward Amplification.....	63
Sensitivity Plots of Dynamic-Load-Transfer Ratio.....	66
Sensitivity Plots of Transient High-Speed Offtracking.....	69
Sensitivity Plots of Damping Ratio in the RTAC-B Maneuver.....	72
SENSITIVITY STUDY RESULTS FOR THE 2C2-DOLLY.....	75
Sensitivity Plots of Static Rollover Threshold.....	76
Sensitivity Plots of High-Speed Steady-State Offtracking.....	79
Sensitivity Plots of Rearward Amplification.....	82
Sensitivity Plots of Dynamic-Load-Transfer Ratio.....	85
Sensitivity Plots of Transient High-Speed Offtracking.....	88



ESTUDIO DE INVESTIGACIÓN DE LA UNIVERSIDAD DE MICHIGAN  
Puede ser consultado en:

<http://www.hti.umich.edu/cgi/t/text/text-idx?sid=50cf84488b83cc2b8ba0554be1cc5c98;c=umtri;idno=88519.0001.001>

Sensitivity Plots of Damping Ratio in the RTAC-B Maneuver .....	91
SENSITIVITY STUDY RESULTS FOR THE 2C3-DOLLY .....	94
Sensitivity Plots of Static Rollover Threshold .....	95
Sensitivity Plots of High-Speed Steady-State Offtracking .....	98
Sensitivity Plots of Rearward Amplification .....	101
Sensitivity Plots of Dynamic-Load-Transfer Ratio .....	104
Sensitivity Plots of Transient High-Speed Offtracking .....	107
Sensitivity Plots of Damping Ratio in the RTAC-B Maneuver .....	110
SENSITIVITY STUDY RESULTS FOR THE 3C1-DOLLY .....	113
Sensitivity Plots of Static Rollover Threshold .....	114
Sensitivity Plots of High-Speed Steady-State Offtracking .....	117
Sensitivity Plots of Rearward Amplification .....	120
Sensitivity Plots of Dynamic-Load-Transfer Ratio .....	123
Sensitivity Plots of Transient High-Speed Offtracking .....	126
Sensitivity Plots of Damping Ratio in the RTAC-B Maneuver .....	129
SENSITIVITY STUDY RESULTS FOR THE 3C2-DOLLY .....	132
Sensitivity Plots of Static Rollover Threshold .....	133
Sensitivity Plots of High-Speed Steady-State Offtracking .....	136
Sensitivity Plots of Rearward Amplification .....	139
Sensitivity Plots of Dynamic-Load-Transfer Ratio .....	142
Sensitivity Plots of Transient High-Speed Offtracking .....	145
Sensitivity Plots of Damping Ratio in the RTAC-B Maneuver .....	148
SENSITIVITY STUDY RESULTS FOR THE 3C3-DOLLY .....	151
Sensitivity Plots of Static Rollover Threshold .....	152
Sensitivity Plots of High-Speed Steady-State Offtracking .....	155
Sensitivity Plots of Rearward Amplification .....	158
Sensitivity Plots of Dynamic-Load-Transfer Ratio .....	161
Sensitivity Plots of Transient High-Speed Offtracking .....	164
Sensitivity Plots of Damping Ratio in the RTAC-B Maneuver .....	167
APPENDIX D: REGRESSION MODEL PARAMETERS .....	171
DATABASE FOR PREDICTING A-TRAIN PERFORMANCE MEASURES .....	172
APPENDIX E: A- AND C-TRAIN PERFORMANCE COMPARISON .....	183
APPENDIX F: DOLLY HITCH LOADING RESULTS .....	197
APPENDIX G: ECONOMIC ANALYSIS .....	215
ACCIDENT ANALYSIS .....	215
Data Sources .....	216
Validating Data Sources .....	220

ESTUDIO DE INVESTIGACIÓN DE LA UNIVERSIDAD DE MICHIGAN

Puede ser consultado en:

<http://www.hti.umich.edu/cgi/t/text/text-idx?sid=50cf84488b83cc2b8ba0554be1cc5c98;c=umtri;idno=88519.0001.001>

Comparison of Accident Rates and Frequencies .....	222
Estimates of Benefits of Innovative Dollies .....	230
<b>FINANCIAL ANALYSIS</b> .....	234
<b>Introduction</b> .....	235
<i>Objective</i> .....	235
<i>Approach</i> .....	235
<i>Method of Analysis</i> .....	236
<i>Data Gathering</i> .....	236
<b>Financial Model</b> .....	236
<i>Type of Analysis</i> .....	236
<i>Life of the Project</i> .....	237
<i>Assumptions Concerning Economic Issues</i> .....	237
<b>The Investment Rule</b> .....	241
<b>Application of the Financial Model</b> .....	241
<i>The Independent Variables</i> .....	241
<b>DISCUSSION OF THE RESULTS</b> .....	243
<b>Net Present Value</b> .....	244
<b>Change in Shipping Charges</b> .....	245
<b>Change in Operating Cost</b> .....	245
<b>Current Operating Environment</b> .....	245

<b>APPENDIX H: RESOLUTION OF THE DIFFERENCES IN REARWARD AMPLIFICATION DETERMINED BY TWO DIFFERENT CALCULATION METHODS</b> .....	253
<b>INTRODUCTION</b> .....	253
<b>METHOD</b> .....	256
<b>RESULTS</b> .....	258
<b>CONCLUSION</b> .....	265

**VOLUME III: TECHNICAL SUMMARY**